

(EG / HDG) H35 Wiremesh Cable Trays

With a width up to 600 mm / height up to 100 mm

It is possible to carry a lot of amount of cable with a width of up to 1000 mm.

Wiremesh Trays can be installed quickly. It provides economic and easy working opportunities.

Ergonomic operation in every assembly area with its suitable design for all cable carrying systems.

www.traycanal.com
export@traycanal.com
 +90 534 598 08 65

www.traycanal.com / Cable Tray / EG H35 Wiremesh Cable Trays

PRODUCT CODE	HEIGHT	WIDTH	THICKNESS ± % 10	WEIGHT (KG/MT)
WM3 050 4CT E	35	50	4	0,378
WM3 100 4CT E	35	100	4	0,506
WM3 150 4CT E	35	150	4	0,635
WM3 200 4CT E	35	200	4	0,764
WM3 250 4CT E	35	250	4	0,893
WM3 300 4CT E	35	300	4	1,022
WM3 350 4CT E	35	350	4	1,150
WM3 400 4CT E	35	400	4	1,279
WM3 450 4CT E	35	450	4	1,408
WM3 500 4CT E	35	500	4	1,537
WM3 550 4CT E	35	550	4	1,666
WM3 600 4CT E	35	600	4	1,794
WM3 050 5CT E	35	50	5	0,609
WM3 100 5CT E	35	100	5	0,817
WM3 150 5CT E	35	150	5	1,025
WM3 200 5CT E	35	200	5	1,233
WM3 250 5CT E	35	250	5	1,441
WM3 300 5CT E	35	300	5	1,648
WM3 350 5CT E	35	350	5	1,856
WM3 400 5CT E	35	400	5	2,064
WM3 450 5CT E	35	450	5	2,272
WM3 500 5CT E	35	500	5	2,480
WM3 550 5CT E	35	550	5	2,688
WM3 600 5CT E	35	600	5	2,895

(EG / HDG) H55 Wiremesh Cable Trays

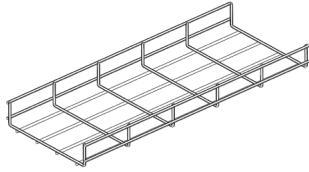

With a width up to 600 mm / height up to 100 mm

It is possible to carry a lot of amount of cable with a width of up to 1000 mm.

Wiremesh Trays can be installed quickly. It provides economic and easy working opportunities.

Ergonomic operation in every assembly area with its suitable design for all cable carrying systems.

www.traycanal.com
export@traycanal.com
 +90 534 598 08 65

www.traycanal.com / Cable Tray / EG H55 Wiremesh Cable Trays

PRODUCT CODE	HEIGHT	WIDTH	THICKNESS ± % 10	WEIGHT (KG/MT)
WM5 050 4CT E	55	50	4	0,574
WM5 100 4CT E	55	100	4	0,703
WM5 150 4CT E	55	150	4	0,832
WM5 200 4CT E	55	200	4	0,961
WM5 250 4CT E	55	250	4	1,089
WM5 300 4CT E	55	300	4	1,218
WM5 350 4CT E	55	350	4	1,347
WM5 400 4CT E	55	400	4	1,476
WM5 450 4CT E	55	450	4	1,605
WM5 500 4CT E	55	500	4	1,862
WM5 550 4CT E	55	550	4	1,862
WM5 600 4CT E	55	600	4	1,991
WM5 050 5CT E	55	50	5	0,927
WM5 100 5CT E	55	100	5	1,134
WM5 150 5CT E	55	150	5	1,342
WM5 200 5CT E	55	200	5	1,550
WM5 250 5CT E	55	250	5	1,758
WM5 300 5CT E	55	300	5	1,966
WM5 350 5CT E	55	350	5	2,173
WM5 400 5CT E	55	400	5	2,381
WM5 450 5CT E	55	450	5	2,589
WM5 500 5CT E	55	500	5	3,005
WM5 550 5CT E	55	550	5	3,005

(EG / HDG) H75 Wiremesh Cable Trays

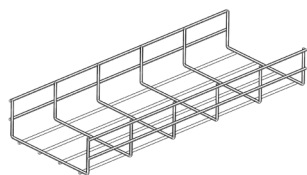

With a width up to 600 mm / height up to 100 mm

It is possible to carry a lot of amount of cable with a width of up to 1000 mm.

Wiremesh Trays can be installed quickly. It provides economic and easy working opportunities.

Ergonomic operation in every assembly area with its suitable design for all cable carrying systems.

www.traycanal.com
export@traycanal.com
+90 534 598 08 65

www.traycanal.com / Cable Tray / EG H75 Wiremesh Cable Trays

PRODUCT CODE	HEIGHT	WIDTH	THICKNESS ± % 10	WEIGHT (KG/MT)
WM7 100 4CT E	75	100	4	0,755
WM7 150 4CT E	75	150	4	0,884
WM7 200 4CT E	75	200	4	1,013
WM7 250 4CT E	75	250	4	1,142
WM7 300 4CT E	75	300	4	1,270
WM7 350 4CT E	75	350	4	1,399
WM7 400 4CT E	75	400	4	1,528
WM7 450 4CT E	75	450	4	1,657
WM7 500 4CT E	75	500	4	1,786
WM7 550 4CT E	75	550	4	1,914
WM7 600 4CT E	75	600	4	2,043
WM7 100 5CT E	75	100	5	1,219
WM7 150 5CT E	75	150	5	1,427
WM7 200 5CT E	75	200	5	1,634
WM7 250 5CT E	75	250	5	1,842
WM7 300 5CT E	75	300	5	2,050
WM7 350 5CT E	75	350	5	2,258
WM7 400 5CT E	75	400	5	2,466
WM7 450 5CT E	75	450	5	2,673
WM7 500 5CT E	75	500	5	2,881
WM7 550 5CT E	75	550	5	3,089

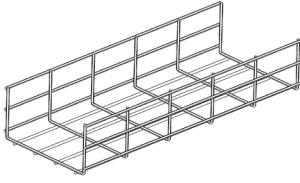

(EG / HDG) H105 Wiremesh Cable Trays

With a width up to 600 mm / height up to 100 mm

It is possible to carry a lot of amount of cable with a width of up to 1000 mm.

Wiremesh Trays can be installed quickly. It provides economic and easy working opportunities.

Ergonomic operation in every assembly area with its suitable design for all cable carrying systems.

www.traycanal.com
export@traycanal.com
 +90 534 598 08 65

www.traycanal.com / Cable Tray / EG H100 Wiremesh Cable Trays

PRODUCT CODE	HEIGHT	WIDTH	THICKNESS ± % 10	WEIGHT (KG/MT)
WM1 100 4CT E	105	100	4	0,961
WM1 150 4CT E	105	150	4	1,089
WM1 200 4CT E	105	200	4	1,218
WM1 250 4CT E	105	250	4	1,347
WM1 300 4CT E	105	300	4	1,476
WM1 350 4CT E	105	350	4	1,605
WM1 400 4CT E	105	400	4	1,733
WM1 450 4CT E	105	450	4	1,862
WM1 500 4CT E	105	500	4	1,991
WM1 550 4CT E	105	550	4	2,120
WM1 600 4CT E	105	600	4	2,249
WM1 100 5CT E	105	100	5	1,550
WM1 150 5CT E	105	150	5	1,758
WM1 200 5CT E	105	200	5	1,966
WM1 250 5CT E	105	250	5	2,173
WM1 300 5CT E	105	300	5	2,381
WM1 350 5CT E	105	350	5	2,589
WM1 400 5CT E	105	400	5	2,797
WM1 450 5CT E	105	450	5	3,005
WM1 500 5CT E	105	500	5	3,213
WM1 550 5CT E	105	550	5	3,420

(EG / HDG / SS304 / SS316) H35-105 Double Wire Mesh

With a width up to 600 mm / height up to 100 mm

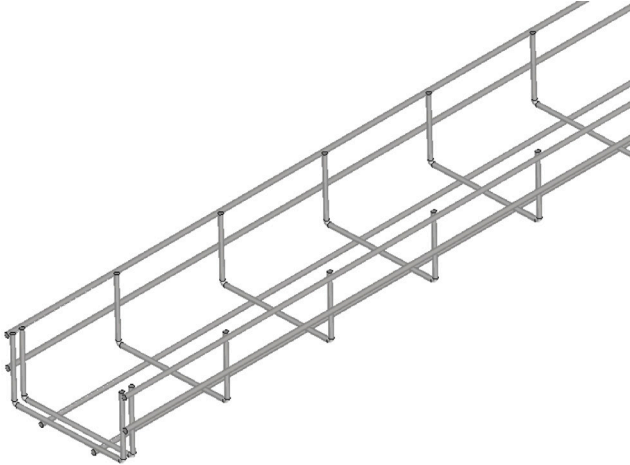

www.traycanal.com / Cable Tray / EG H55 Wiremesh Cable Trays

PRODUCT CODE	HEIGHT	WIDTH	THICKNESS \pm % 10	WEIGHT (KG/MT)
WM5 050 4CT E	35-105	50	4-5	0,574
WM5 100 4CT E	35-105	100	4-5	0,703
WM5 150 4CT E	35-105	150	4-5	0,832
WM5 200 4CT E	35-105	200	4-5	0,961
WM5 250 4CT E	35-105	250	4-5	1,089
WM5 300 4CT E	35-105	300	4-5	1,218
WM5 350 4CT E	35-105	350	4-5	1,347
WM5 400 4CT E	35-105	400	4-5	1,476
WM5 450 4CT E	35-105	450	4-5	1,605
WM5 500 4CT E	35-105	500	4-5	1,862
WM5 550 4CT E	35-105	550	4-5	1,862
WM5 600 4CT E	35-105	600	4-5	1,991

(EG / HDG / SS304 / SS316) H35-105 Waved Wire Mesh Cable Tray

With a width up to 600 mm / height up to 100 mm

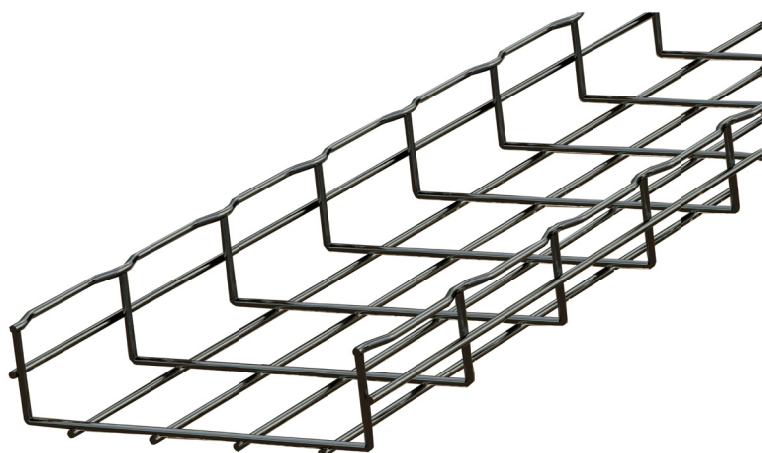

www.traycanal.com / Cable Tray / EG H55 Wiremesh Cable Trays

PRODUCT CODE	HEIGHT	WIDTH	THICKNESS \pm % 10	WEIGHT (KG/MT)
WM5 050 4CT E	35-105	50	4-5	0,574
WM5 100 4CT E	35-105	100	4-5	0,703
WM5 150 4CT E	35-105	150	4-5	0,832
WM5 200 4CT E	35-105	200	4-5	0,961
WM5 250 4CT E	35-105	250	4-5	1,089
WM5 300 4CT E	35-105	300	4-5	1,218
WM5 350 4CT E	35-105	350	4-5	1,347
WM5 400 4CT E	35-105	400	4-5	1,476
WM5 450 4CT E	35-105	450	4-5	1,605
WM5 500 4CT E	35-105	500	4-5	1,862
WM5 550 4CT E	35-105	550	4-5	1,862
WM5 600 4CT E	35-105	600	4-5	1,991

(EG / HDG / SS304 / SS316) H35-105 Curved Wire Mesh

With a width up to 600 mm / height up to 100 mm



www.traycanal.com / Cable Tray / EG H55 Wiremesh Cable Trays

PRODUCT CODE	HEIGHT	WIDTH	THICKNESS \pm % 10	WEIGHT (KG/MT)
WM5 050 4CT E	35-105	50	4-5	0,574
WM5 100 4CT E	35-105	100	4-5	0,703
WM5 150 4CT E	35-105	150	4-5	0,832
WM5 200 4CT E	35-105	200	4-5	0,961
WM5 250 4CT E	35-105	250	4-5	1,089
WM5 300 4CT E	35-105	300	4-5	1,218
WM5 350 4CT E	35-105	350	4-5	1,347
WM5 400 4CT E	35-105	400	4-5	1,476
WM5 450 4CT E	35-105	450	4-5	1,605
WM5 500 4CT E	35-105	500	4-5	1,862
WM5 550 4CT E	35-105	550	4-5	1,862
WM5 600 4CT E	35-105	600	4-5	1,991

(EG / HDG / SS304 / SS316) H35-105 Self Lock Wire

With a width up to 600 mm / height up to 100 mm

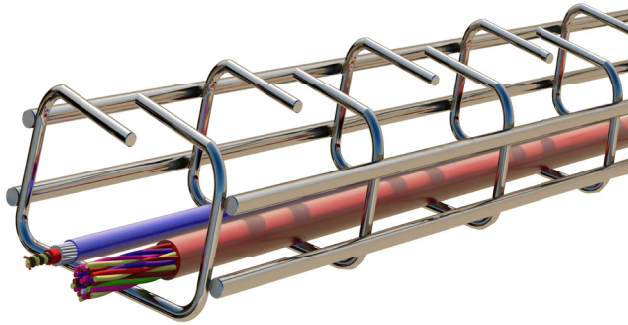

www.traycanal.com / Cable Tray / EG H55 Wiremesh Cable Trays

PRODUCT CODE	HEIGHT	WIDTH	THICKNESS ± % 10	WEIGHT (KG/MT)
WM5 050 4CT E	35-105	50	4-5	0,574
WM5 100 4CT E	35-105	100	4-5	0,703
WM5 150 4CT E	35-105	150	4-5	0,832
WM5 200 4CT E	35-105	200	4-5	0,961
WM5 250 4CT E	35-105	250	4-5	1,089
WM5 300 4CT E	35-105	300	4-5	1,218
WM5 350 4CT E	35-105	350	4-5	1,347
WM5 400 4CT E	35-105	400	4-5	1,476
WM5 450 4CT E	35-105	450	4-5	1,605
WM5 500 4CT E	35-105	500	4-5	1,862
WM5 550 4CT E	35-105	550	4-5	1,862
WM5 600 4CT E	35-105	600	4-5	1,991

(EG / HDG / SS304 / SS316) H35-105 G-Type Mesh Ca-

With a width up to 600 mm / height up to 100 mm

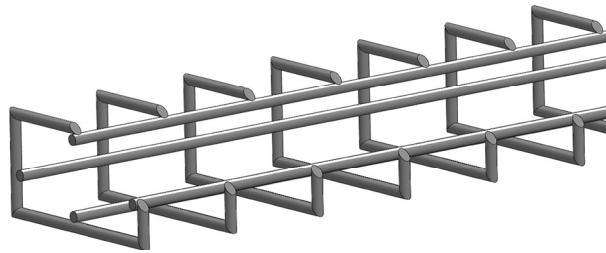
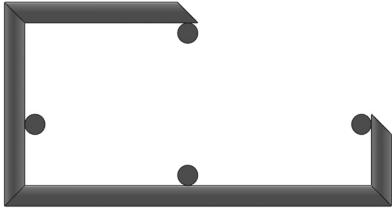

www.traycanal.com / Cable Tray / EG H55 Wiremesh Cable Trays

PRODUCT CODE	HEIGHT	WIDTH	THICKNESS \pm % 10	WEIGHT (KG/MT)
WM5 050 4CT E	35-105	50	4-5	0,574
WM5 100 4CT E	35-105	100	4-5	0,703
WM5 150 4CT E	35-105	150	4-5	0,832
WM5 200 4CT E	35-105	200	4-5	0,961
WM5 250 4CT E	35-105	250	4-5	1,089
WM5 300 4CT E	35-105	300	4-5	1,218
WM5 350 4CT E	35-105	350	4-5	1,347
WM5 400 4CT E	35-105	400	4-5	1,476
WM5 450 4CT E	35-105	450	4-5	1,605
WM5 500 4CT E	35-105	500	4-5	1,862
WM5 550 4CT E	35-105	550	4-5	1,862
WM5 600 4CT E	35-105	600	4-5	1,991

(EG / HDG / SS304 / SS316) H35 Wiremesh Cable Tray 90° Bends

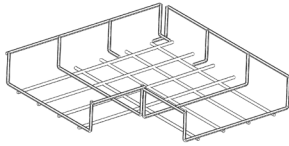

It is possible to carry a lot of amount of cable with a width of up to 1000 mm.

Wiremesh Trays can be installed quickly. It provides economic and easy working opportunities.

Ergonomic operation in every assembly area with its suitable design for all cable carrying systems.

www.traycanal.com
export@traycanal.com
 +90 534 598 08 65

With a width up to 600 mm / height up to 100 mm

www.traycanal.com / Wiremesh Cable Tray / H35 EG 90° Bends

PRODUCT CODE	HEIGHT	WIDTH	THICKNESS ± % 10	WEIGHT (KG/PCS)
WM3 050 4LB E	35	50	4	0,108
WM3 100 4LB E	35	100	4	0,192
WM3 150 4LB E	35	150	4	0,302
WM3 200 4LB E	35	200	4	0,435
WM3 250 4LB E	35	250	4	0,594
WM3 300 4LB E	35	300	4	0,776
WM3 350 4LB E	35	350	4	0,984
WM3 400 4LB E	35	400	4	1,215
WM3 450 4LB E	35	450	4	1,471
WM3 500 4LB E	35	500	4	1,752
WM3 550 4LB E	35	550	4	2,057
WM3 600 4LB E	35	600	4	2,387
WM3 050 5LB E	35	50	5	0,174
WM3 100 5LB E	35	100	5	0,311
WM3 150 5LB E	35	150	5	0,487
WM3 200 5LB E	35	200	5	0,703
WM3 250 5LB E	35	250	5	0,958
WM3 300 5LB E	35	300	5	1,253
WM3 350 5LB E	35	350	5	1,587
WM3 400 5LB E	35	400	5	1,961
WM3 450 5LB E	35	450	5	2,374
WM3 500 5LB E	35	500	5	2,827
WM3 550 5LB E	35	550	5	3,319
WM3 600 5LB E	35	600	5	3,851

(EG / HDG / SS304 / SS316) H55 Wiremesh Cable Tray 90° Bends

With a width up to 600 mm / height up to 100 mm

It is possible to carry a lot of amount of cable with a width of up to 1000 mm.

Wiremesh Trays can be installed quickly. It provides economic and easy working opportunities.

Ergonomic operation in every assembly area with its suitable design for all cable carrying systems.

www.traycanal.com
export@traycanal.com
 +90 534 598 08 65

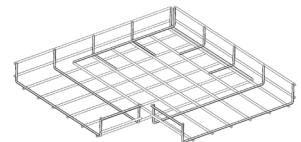

www.traycanal.com / Wiremesh Cable Tray / H50 EG 90° Bends

PRODUCT CODE	HEIGHT	WIDTH	THICKNESS ± % 10	WEIGHT (KG/PCS)
WM5 050 4LB E	55	50	4	0,164
WM5 100 4LB E	55	100	4	0,267
WM5 150 4LB E	55	150	4	0,395
WM5 200 4LB E	55	200	4	0,548
WM5 250 4LB E	55	250	4	0,724
WM5 300 4LB E	55	300	4	0,926
WM5 350 4LB E	55	350	4	1,152
WM5 400 4LB E	55	400	4	1,402
WM5 450 4LB E	55	450	4	1,677
WM5 500 4LB E	55	500	4	2,123
WM5 550 4LB E	55	550	4	2,300
WM5 600 4LB E	55	600	4	2,648
WM5 050 5LB E	55	50	5	0,264
WM5 100 5LB E	55	100	5	0,431
WM5 150 5LB E	55	150	5	0,638
WM5 200 5LB E	55	200	5	0,883
WM5 250 5LB E	55	250	5	1,169
WM5 300 5LB E	55	300	5	1,494
WM5 350 5LB E	55	350	5	1,858
WM5 400 5LB E	55	400	5	2,262
WM5 450 5LB E	55	450	5	2,706
WM5 500 5LB E	55	500	5	3,425
WM5 550 5LB E	55	550	5	3,711
WM5 600 5LB E	55	600	5	4,273

(EG / HDG / SS304 / SS316) H75 Wiremesh Cable Tray 90° Bends

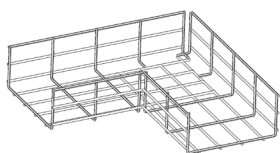

With a width up to 600 mm / height up to 100 mm

It is possible to carry a lot of amount of cable with a width of up to 1000 mm.

Wiremesh Trays can be installed quickly. It provides economic and easy working opportunities.

Ergonomic operation in every assembly area with its suitable design for all cable carrying systems.

www.traycanal.com
export@traycanal.com
 +90 534 598 08 65

www.traycanal.com / Wiremesh Cable Tray / H75 EG 90° Bends

PRODUCT CODE	HEIGHT	WIDTH	THICKNESS ± % 10	WEIGHT (KG/PCS)
WM7 100 4LB E	75	100	4	0,287
WM7 150 4LB E	75	150	4	0,420
WM7 200 4LB E	75	200	4	0,577
WM7 250 4LB E	75	250	4	0,759
WM7 300 4LB E	75	300	4	0,966
WM7 350 4LB E	75	350	4	1,196
WM7 400 4LB E	75	400	4	1,452
WM7 450 4LB E	75	450	4	1,731
WM7 500 4LB E	75	500	4	2,036
WM7 550 4LB E	75	550	4	2,364
WM7 600 4LB E	75	600	4	2,717
WM7 100 5LB E	75	100	5	0,463
WM7 150 5LB E	75	150	5	0,678
WM7 200 5LB E	75	200	5	0,932
WM7 250 5LB E	75	250	5	1,225
WM7 300 5LB E	75	300	5	1,558
WM7 350 5LB E	75	350	5	1,930
WM7 400 5LB E	75	400	5	2,342
WM7 450 5LB E	75	450	5	2,794
WM7 500 5LB E	75	500	5	3,285

(EG / HDG / SS304 / SS316) H105 Wiremesh

With a width up to 600 mm / height up to 100 mm

It is possible to carry a lot of amount of cable with a width of up to 1000 mm.

Wiremesh Trays can be installed quickly. It provides economic and easy working opportunities.

Ergonomic operation in every assembly area with its suitable design for all cable carrying systems.

www.traycanal.com
export@traycanal.com
 +90 534 598 08 65

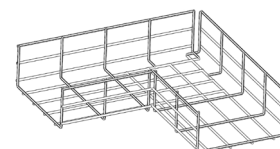

www.traycanal.com / Wiremesh Cable Tray / H100 EG 90° Bends

PRODUCT CODE	HEIGHT	WIDTH	THICKNESS ± % 10	WEIGHT (KG/PCS)
WM1 100 4LB E	105	100	4	0,365
WM1 150 4LB E	105	150	4	0,517
WM1 200 4LB E	105	200	4	0,694
WM1 250 4LB E	105	250	4	0,896
WM1 300 4LB E	105	300	4	1,122
WM1 350 4LB E	105	350	4	1,372
WM1 400 4LB E	105	400	4	1,647
WM1 450 4LB E	105	450	4	1,946
WM1 500 4LB E	105	500	4	2,270
WM1 550 4LB E	105	550	4	2,618
WM1 600 4LB E	105	600	4	2,991
WM1 100 5LB E	105	100	5	0,589
WM1 150 5LB E	105	150	5	0,835
WM1 200 5LB E	105	200	5	1,120
WM1 250 5LB E	105	250	5	1,445
WM1 300 5LB E	105	300	5	1,810
WM1 350 5LB E	105	350	5	2,214
WM1 400 5LB E	105	400	5	2,657
WM1 450 5LB E	105	450	5	3,140
WM1 500 5LB E	105	500	5	3,662

(EG / HDG / SS304 / SS316) H35-105

Wiremesh Cable Tray Tee Bends

With a width up to 600 mm / height up to 100 mm

It is possible to carry a lot of amount of cable with a width of up to 1000 mm.

Wiremesh Trays can be installed quickly. It provides economic and easy working opportunities.

Ergonomic operation in every assembly area with its suitable design for all cable carrying systems.

www.traycanal.com
export@traycanal.com
+90 534 598 08 65

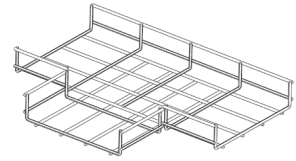

www.traycanal.com / Wiremesh Cable Tray / H50 EG Tee Bends

PRODUCT CODE	HEIGHT	WIDTH	THICKNESS ± % 10	WEIGHT (KG/PCS)
WM5 050 4TB E	55	50	4	0,218
WM5 100 4TB E	55	100	4	0,334
WM5 150 4TB E	55	150	4	0,474
WM5 200 4TB E	55	200	4	0,639
WM5 250 4TB E	55	250	4	0,828
WM5 300 4TB E	55	300	4	1,042
WM5 350 4TB E	55	350	4	1,280
WM5 400 4TB E	55	400	4	1,542
WM5 450 4TB E	55	450	4	1,829
WM5 500 4TB E	55	500	4	2,300
WM5 550 4TB E	55	550	4	2,477
WM5 600 4TB E	55	600	4	2,837
WM5 050 5TB E	55	50	5	0,352
WM5 100 5TB E	55	100	5	0,539
WM5 150 5TB E	55	150	5	0,765
WM5 200 5TB E	55	200	5	1,031
WM5 250 5TB E	55	250	5	1,336
WM5 300 5TB E	55	300	5	1,681
WM5 350 5TB E	55	350	5	2,065
WM5 400 5TB E	55	400	5	2,488
WM5 450 5TB E	55	450	5	2,952
WM5 500 5TB E	55	500	5	3,711
WM5 550 5TB E	55	550	5	3,996
WM5 600 5TB E	55	600	5	4,578

(EG / HDG / SS304 / SS316) H35-105

Wiremesh Cable Tray Four Way Bends

With a width up to 600 mm / height up to 100 mm

It is possible to carry a lot of amount of cable with a width of up to 1000 mm.

Wiremesh Trays can be installed quickly. It provides economic and easy working opportunities.

Ergonomic operation in every assembly area with its suitable design for all cable carrying systems.

www.traycanal.com
export@traycanal.com
+90 534 598 08 65

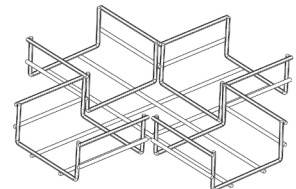

www.traycanal.com / Wiremesh Cable Tray / H50 EG Four Way Bends

PRODUCT CODE	HEIGHT	WIDTH	THICKNESS ± % 10	WEIGHT (KG/PCS)
WM5 050 4FB E	55	50	4	0,273
WM5 100 4FB E	55	100	4	0,401
WM5 150 4FB E	55	150	4	0,553
WM5 200 4FB E	55	200	4	0,730
WM5 250 4FB E	55	250	4	0,931
WM5 300 4FB E	55	300	4	1,157
WM5 350 4FB E	55	350	4	1,408
WM5 400 4FB E	55	400	4	1,682
WM5 450 4FB E	55	450	4	1,982
WM5 500 4FB E	55	500	4	2,477
WM5 550 4FB E	55	550	4	2,654
WM5 600 4FB E	55	600	4	3,026
WM5 050 5FB E	55	50	5	0,440
WM5 100 5FB E	55	100	5	0,647
WM5 150 5FB E	55	150	5	0,893
WM5 200 5FB E	55	200	5	1,178
WM5 250 5FB E	55	250	5	1,503
WM5 300 5FB E	55	300	5	1,867
WM5 350 5FB E	55	350	5	2,271
WM5 400 5FB E	55	400	5	2,715
WM5 450 5FB E	55	450	5	3,198
WM5 500 5FB E	55	500	5	3,996
WM5 550 5FB E	55	550	5	4,282
WM5 600 5FB E	55	600	5	4,883

(EG / HDG / SS304 / SS316) H35-105 Wiremesh Cable Tray 90° Inside-Outside Bends

With a width up to 600 mm / height up to 100 mm

It is possible to carry a lot of amount of cable with a width of up to 1000 mm.

Wiremesh Trays can be installed quickly. It provides economic and easy working opportunities.

Ergonomic operation in every assembly area with its suitable design for all cable carrying systems.

www.traycanal.com
export@traycanal.com
 +90 534 598 08 65

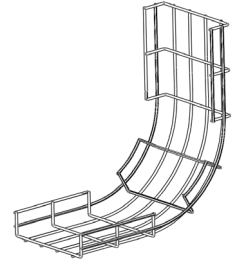
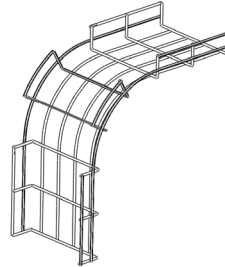

www.traycanal.com / Wiremesh Cable Tray / H50 EG 90° Inside Bends

PRODUCT CODE	HEIGHT	WIDTH	THICKNESS ± % 10	WEIGHT (KG/PCS)
WM5 050 4IB E	55	50	4	0,382
WM5 100 4IB E	55	100	4	0,468
WM5 150 4IB E	55	150	4	0,553
WM5 200 4IB E	55	200	4	0,639
WM5 250 4IB E	55	250	4	0,724
WM5 300 4IB E	55	300	4	0,810
WM5 350 4IB E	55	350	4	0,896
WM5 400 4IB E	55	400	4	0,981
WM5 450 4IB E	55	450	4	1,067
WM5 500 4IB E	55	500	4	1,238
WM5 550 4IB E	55	550	4	1,238
WM5 600 4IB E	55	600	4	1,324
WM5 050 5IB E	55	50	5	0,616
WM5 100 5IB E	55	100	5	0,754
WM5 150 5IB E	55	150	5	0,893
WM5 200 5IB E	55	200	5	1,031
WM5 250 5IB E	55	250	5	1,169
WM5 300 5IB E	55	300	5	1,307
WM5 350 5IB E	55	350	5	1,445
WM5 400 5IB E	55	400	5	1,584
WM5 450 5IB E	55	450	5	1,722
WM5 500 5IB E	55	500	5	1,998
WM5 550 5IB E	55	550	5	1,998
WM5 600 5IB E	55	600	5	2,136

(EG / HDG / SS304 / SS316) H35-105 Standart Fast & Safe Connector



With a width up to 600 mm / height up to 100 mm

It is possible to carry a lot of amount of cable with a width of up to 1000 mm.

Wiremesh Trays can be installed quickly. It provides economic and easy working opportunities.

Ergonomic operation in every assembly area with its suitable design for all cable carrying systems.

www.traycanal.com
export@traycanal.com
+90 534 598 08 65

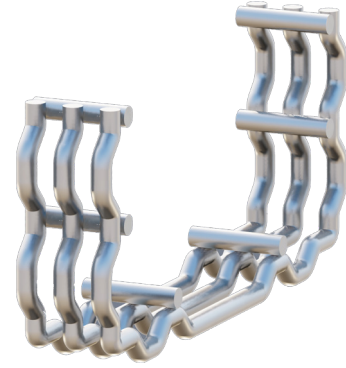
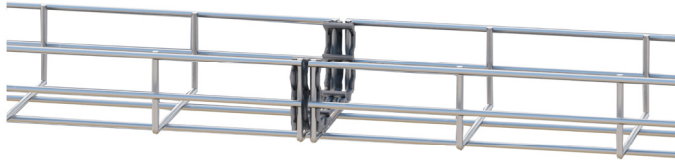

www.traycanal.com / Wiremesh Cable Tray Carrier / U Type Carriers

PRODUCT CODE	HEIGHT	WIDTH	THICKNESS \pm % 10	WEIGHT (KG/PCS)
WMS 060 P	100	60	2,0	0,135
WMS 100 P	100	110	2,0	0,177
WMS 150 P	100	160	2,0	0,219
WMS 200 P	100	210	2,0	0,261
WMS 250 P	100	260	2,0	0,303
WMS 300 P	100	310	2,0	0,345
WMS 060 H	100	60	2,0	0,140
WMS 100 H	100	110	2,0	0,184
WMS 150 H	100	160	2,0	0,228
WMS 200 H	100	210	2,0	0,272
WMS 250 H	100	260	2,0	0,315

(EG / HDG / SS304 / SS316) H35-105

Handle Heavy Duty Fast & Safe Connector

With a width up to 600 mm / height up to 100 mm

It is possible to carry a lot of amount of cable with a width of up to 1000 mm.

Wiremesh Trays can be installed quickly. It provides economic and easy working opportunities.

Ergonomic operation in every assembly area with its suitable design for all cable carrying systems.

www.traycanal.com
export@traycanal.com
 +90 534 598 08 65

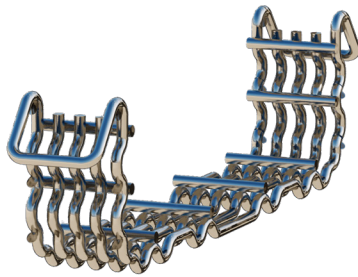

www.traycanal.com / Wiremesh Cable Tray Carrier / U Type Carriers

PRODUCT CODE	HEIGHT	WIDTH	THICKNESS \pm % 10	WEIGHT (KG/PCS)
WMS 060 P	100	60	2,0	0,135
WMS 100 P	100	110	2,0	0,177
WMS 150 P	100	160	2,0	0,219
WMS 200 P	100	210	2,0	0,261
WMS 250 P	100	260	2,0	0,303
WMS 300 P	100	310	2,0	0,345
WMS 060 H	100	60	2,0	0,140
WMS 100 H	100	110	2,0	0,184
WMS 150 H	100	160	2,0	0,228
WMS 200 H	100	210	2,0	0,272
WMS 250 H	100	260	2,0	0,315

(EG / HDG / SS304 / SS316) Wall Support

With a width up to 600 mm / height up to 100 mm

It is possible to carry a lot of amount of cable with a width of up to 1000 mm.

Wiremesh Trays can be installed quickly. It provides economic and easy working opportunities.

Ergonomic operation in every assembly area with its suitable design for all cable carrying systems.

www.traycanal.com
export@traycanal.com
 +90 534 598 08 65

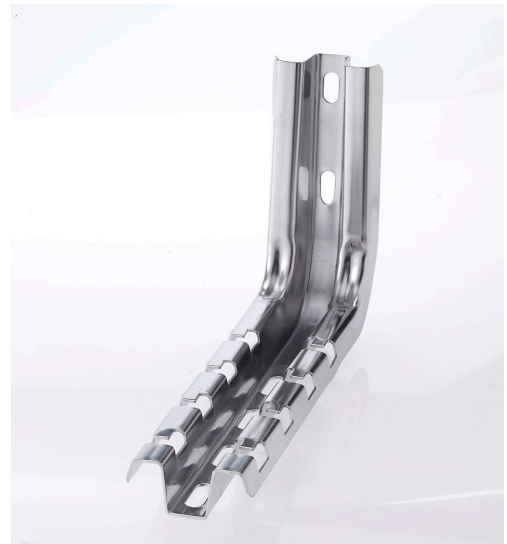
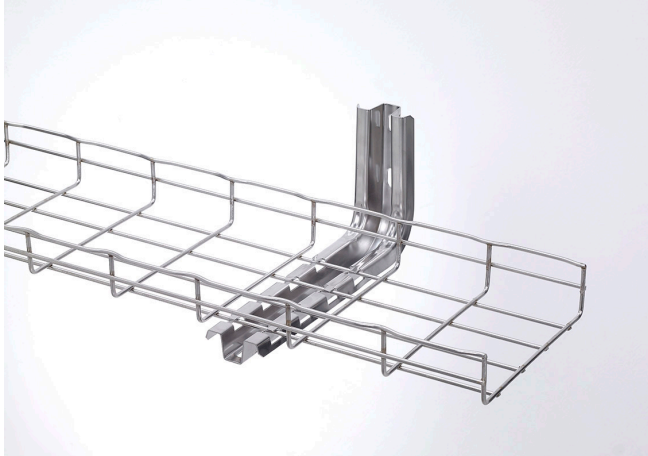

www.traycanal.com / Wiremesh Cable Tray Carrier / U Type Carriers

PRODUCT CODE	HEIGHT	WIDTH	THICKNESS \pm % 10	WEIGHT (KG/PCS)
WMS 060 P	100	60	2,0	0,135
WMS 100 P	100	110	2,0	0,177
WMS 150 P	100	160	2,0	0,219
WMS 200 P	100	210	2,0	0,261
WMS 250 P	100	260	2,0	0,303
WMS 300 P	100	310	2,0	0,345
WMS 060 H	100	60	2,0	0,140
WMS 100 H	100	110	2,0	0,184
WMS 150 H	100	160	2,0	0,228
WMS 200 H	100	210	2,0	0,272
WMS 250 H	100	260	2,0	0,315

(EG / HDG / SS304 / SS316) C Type Wall Support

With a width up to 600 mm / height up to 100 mm

It is possible to carry a lot of amount of cable with a width of up to 1000 mm.

Wiremesh Trays can be installed quickly. It provides economic and easy working opportunities.

Ergonomic operation in every assembly area with its suitable design for all cable carrying systems.

www.traycanal.com
export@traycanal.com
+90 534 598 08 65

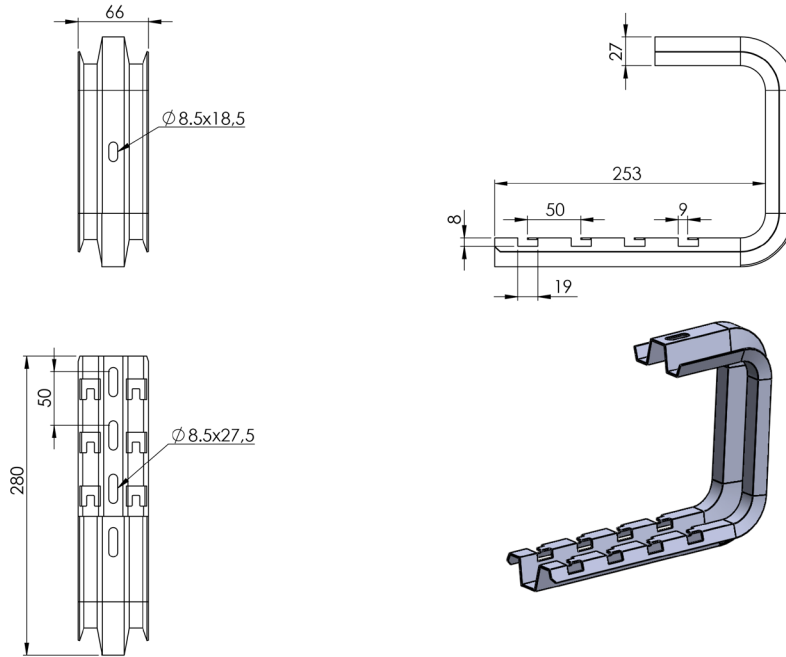

www.traycanal.com / Wiremesh Cable Tray Carrier / U Type Carriers

PRODUCT CODE	HEIGHT	WIDTH	THICKNESS ± % 10	WEIGHT (KG/PCS)
WMS 060 P	100	60	2,0	0,135
WMS 100 P	100	110	2,0	0,177
WMS 150 P	100	160	2,0	0,219
WMS 200 P	100	210	2,0	0,261
WMS 250 P	100	260	2,0	0,303
WMS 300 P	100	310	2,0	0,345
WMS 060 H	100	60	2,0	0,140
WMS 100 H	100	110	2,0	0,184
WMS 150 H	100	160	2,0	0,228
WMS 200 H	100	210	2,0	0,272
WMS 250 H	100	260	2,0	0,315

(EG / HDG / SS304 / SS316)

Omega Floor Mounting

With a width up to 600 mm / height up to 100 mm

It is possible to carry a lot of amount of cable with a width of up to 1000 mm.

Wiremesh Trays can be installed quickly. It provides economic and easy working opportunities.

Ergonomic operation in every assembly area with its suitable design for all cable carrying systems.

www.traycanal.com
export@traycanal.com
+90 534 598 08 65

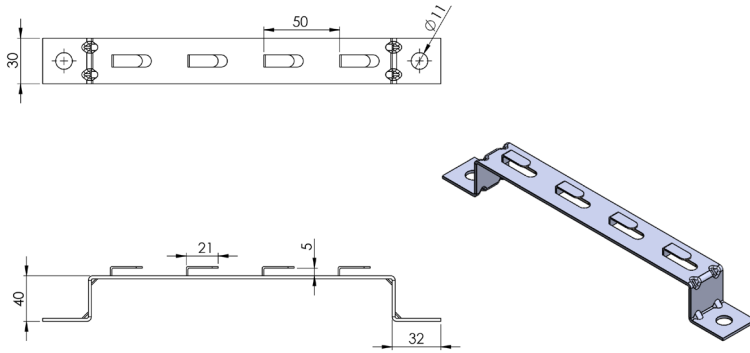

www.traycanal.com / Wiremesh Cable Tray Carrier / U Type Carriers

PRODUCT CODE	HEIGHT	WIDTH	THICKNESS \pm % 10	WEIGHT (KG/PCS)
WMS 060 P	100	60	2,0	0,135
WMS 100 P	100	110	2,0	0,177
WMS 150 P	100	160	2,0	0,219
WMS 200 P	100	210	2,0	0,261
WMS 250 P	100	260	2,0	0,303
WMS 300 P	100	310	2,0	0,345
WMS 060 H	100	60	2,0	0,140
WMS 100 H	100	110	2,0	0,184
WMS 150 H	100	160	2,0	0,228
WMS 200 H	100	210	2,0	0,272
WMS 250 H	100	260	2,0	0,315

(EG / HDG / SS304 / SS316) Floor Mounting & Supporter With Rod

CK-KKTB

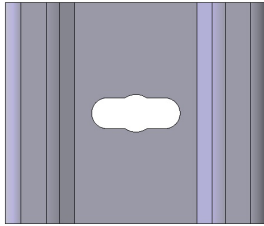
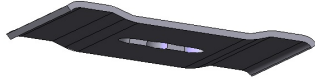

(EG / HDG / SS304 / SS316) Omega Floor Mounting

With a width up to 600 mm / height up to 100 mm

It is possible to carry a lot of amount of cable with a width of up to 1000 mm.

Wiremesh Trays can be installed quickly. It provides economic and easy working opportunities.

Ergonomic operation in every assembly area with its suitable design for all cable carrying systems.

www.traycanal.com
export@traycanal.com
 +90 534 598 08 65

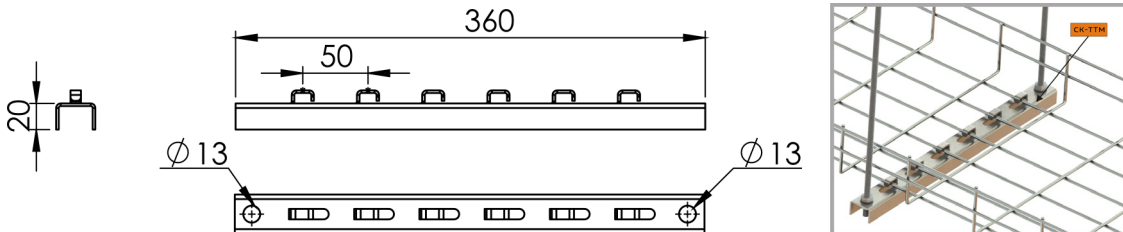

www.traycanal.com / Wiremesh Cable Tray Carrier / U Type Carriers

PRODUCT CODE	HEIGHT	WIDTH	THICKNESS ± % 10	WEIGHT (KG/PCS)
WMS 060 P	100	60	2,0	0,135
WMS 100 P	100	110	2,0	0,177
WMS 150 P	100	160	2,0	0,219
WMS 200 P	100	210	2,0	0,261
WMS 250 P	100	260	2,0	0,303
WMS 300 P	100	310	2,0	0,345
WMS 060 H	100	60	2,0	0,140
WMS 100 H	100	110	2,0	0,184
WMS 150 H	100	160	2,0	0,228
WMS 200 H	100	210	2,0	0,272
WMS 250 H	100	260	2,0	0,315

(EG / HDG / SS304 / SS316)

Wire Mesh Couplers

With a width up to 600 mm / height up to 100 mm

It is possible to carry a lot of amount of cable with a width of up to 1000 mm.

Wiremesh Trays can be installed quickly. It provides economic and easy working opportunities.

Ergonomic operation in every assembly area with its suitable design for all cable carrying systems.

www.traycanal.com
export@traycanal.com
+90 534 598 08 65

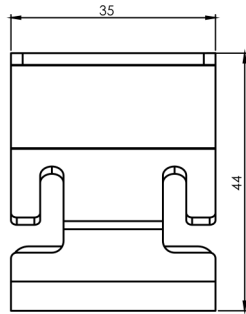
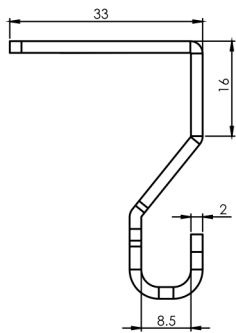

CK-TKC

(EG / HDG / SS304 / SS316) Cable Tray Claw Carrier

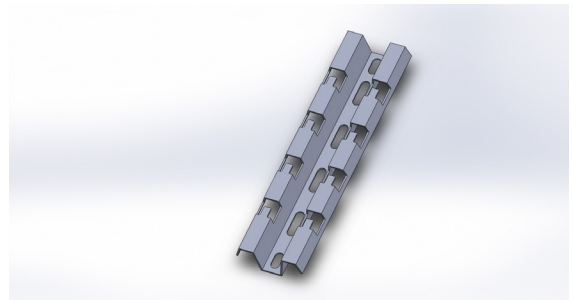
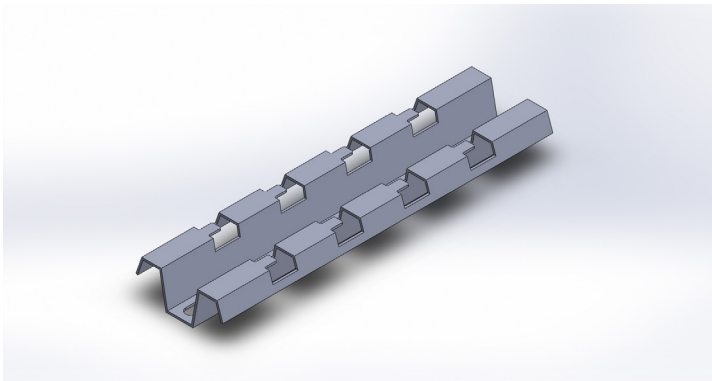

www.traycanal.com / Wiremesh Cable Tray Carrier / U Type Carriers

PRODUCT CODE	HEIGHT	WIDTH	THICKNESS \pm % 10
WMS 060 P	100	60	2,0
WMS 100 P	100	110	2,0
WMS 150 P	100	160	2,0
WMS 200 P	100	210	2,0

(EG / HDG / SS304 / SS316)

Cable Transition Part

With a width up to 600 mm / height up to 100 mm

It is possible to carry a lot of amount of cable with a width of up to 1000 mm.

Wiremesh Trays can be installed quickly. It provides economic and easy working opportunities.

Ergonomic operation in every assembly area with its suitable design for all cable carrying systems.

www.traycanal.com
export@traycanal.com
+90 534 598 08 65

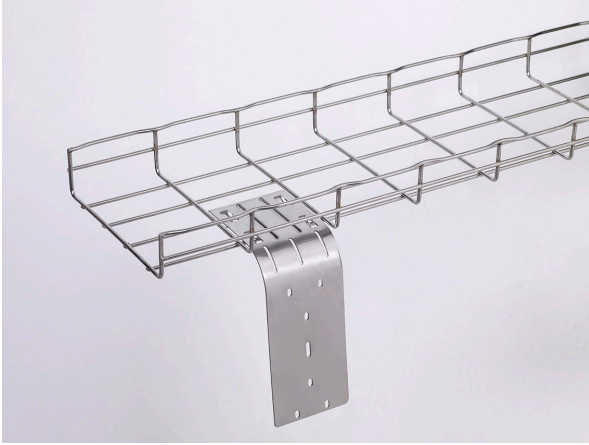

CK-KKGS

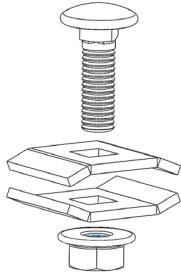

(EG / HDG / SS304 / SS316)

Wiremesh Cable Tray Connector

Hızlı Montaj / Farklı Yüzey Kaplama Seçeneği / Ekonomik Seri

Tel kablo kanallarının hızlı bir şekilde montaj yerinde birbirine bağlanabilmesi için uygun bir üründür.

Yüzey kaplama seçeneği mevcuttur. Kullanım yerine uygun olarak PG yada EG olarak seçim yapılabilir.

Tel kablo taşıma sistemleri için uygun tasarımı ile her montaj alanında ergonomik ve ekonomik çalışma imkanı sağlar.

www.traycanal.com / Cable Tray / Wiremesh Cable Trays Couplers

PRODUCT CODE

HEIGHT

WIDTH

THICKNESS \pm % 10

WEIGHT (KG/PCS)

(EG / HDG / SS304 / SS316)

Wire Mesh Connector

With a width up to 600 mm / height up to 100 mm

It is possible to carry a lot of amount of cable with a width of up to 1000 mm.

Wiremesh Trays can be installed quickly. It provides economic and easy working opportunities.

Ergonomic operation in every assembly area with its suitable design for all cable carrying systems.

CK-KKIB



(EG / HDG / SS304 / SS316)

Floor Mounting Support

With a width up to 600 mm / height up to 100 mm

It is possible to carry a lot of amount of cable with a width of up to 1000 mm.

Wiremesh Trays can be installed quickly. It provides economic and easy working opportunities.

Ergonomic operation in every assembly area with its suitable design for all cable carrying systems.

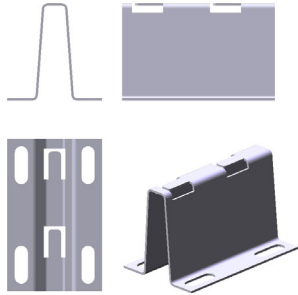

CK-KKYB

(EG / HDG / SS304 / SS316)

Turn Lock

With a width up to 600 mm / height up to 100 mm

It is possible to carry a lot of amount of cable with a width of up to 1000 mm.

Wiremesh Trays can be installed quickly. It provides economic and easy working opportunities.

Ergonomic operation in every assembly area with its suitable design for all cable carrying systems.



CK-KKDK-M

CK-KKDK-S



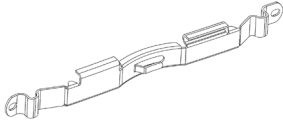

(PG/HDG) Wiremesh Cable Tray Cou-

With a width up to 600 mm / height up to 100 mm

It is possible to carry a lot of amount of cable with a width of up to 1000 mm.

Wiremesh Trays can be installed quickly. It provides economic and easy working opportunities.

Ergonomic operation in every assembly area with its suitable design for all cable carrying systems.

www.traycanal.com
export@traycanal.com
 +90 534 598 08 65

www.traycanal.com / Cable Tray / EG H100 Wiremesh Cable Trays Couplers

PRODUCT CODE	HEIGHT	WIDTH	THICKNESS ± % 10	EG WEIGHT (KG/PCS)
WMC 2 P	3	225	1,5	0,160

(PG / HDG) Wiremesh Cable Tray Covers

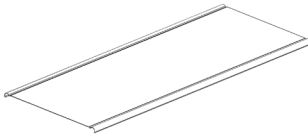

With a width up to 600 mm / height up to 100 mm

It is possible to carry a lot of amount of cable with a width of up to 1000 mm.

Wiremesh Trays can be installed quickly. It provides economic and easy working opportunities.

Ergonomic operation in every assembly area with its suitable design for all cable carrying systems.

www.traycanal.com
export@traycanal.com
 +90 534 598 08 65

www.traycanal.com / Wiremesh Cable Tray / Covers

PRODUCT CODE	HEIGHT	WIDTH	THICKNESS ± % 10	WEIGHT (KG/PCS)
WMC 050 9CO P	10	60	0,9	0,502
WMC 100 9CO P	10	110	0,9	0,816
WMC 150 9CO P	10	160	0,9	1,130
WMC 200 9CO P	10	210	0,9	1,444
WMC 250 9CO P	10	260	0,9	1,758
WMC 300 9CO P	10	310	0,9	2,072
WMC 350 9CO P	10	360	0,9	2,386
WMC 400 9CO P	10	410	0,9	2,700
WMC 450 9CO P	10	460	0,9	3,014
WMC 500 9CO P	10	510	0,9	3,328
WMC 550 9CO P	10	560	0,9	3,642
WMC 600 9CO P	10	610	0,9	3,956
WMC 050 9CO H	10	60	1,0	0,538
WMC 100 9CO H	10	110	1,0	0,874
WMC 150 9CO H	10	160	1,0	1,210
WMC 200 9CO H	10	210	1,0	1,546
WMC 250 9CO H	10	260	1,0	1,881
WMC 300 9CO H	10	310	1,0	2,217
WMC 350 9CO H	10	360	1,0	2,553
WMC 400 9CO H	10	410	1,0	2,889
WMC 450 9CO H	10	460	1,0	3,225
WMC 500 9CO H	10	510	1,0	3,561
WMC 550 9CO H	10	560	1,0	3,897
WMC 600 9CO H	10	610	1,0	4,233

(EG / HDG / SS304 / SS316)

Floor Mounting Support

With a width up to 600 mm / height up to 100 mm

It is possible to carry a lot of amount of cable with a width of up to 1000 mm.

Wiremesh Trays can be installed quickly. It provides economic and easy working opportunities.

Ergonomic operation in every assembly area with its suitable design for all cable carrying systems.

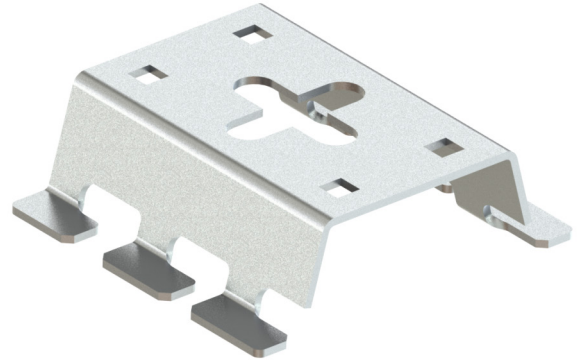
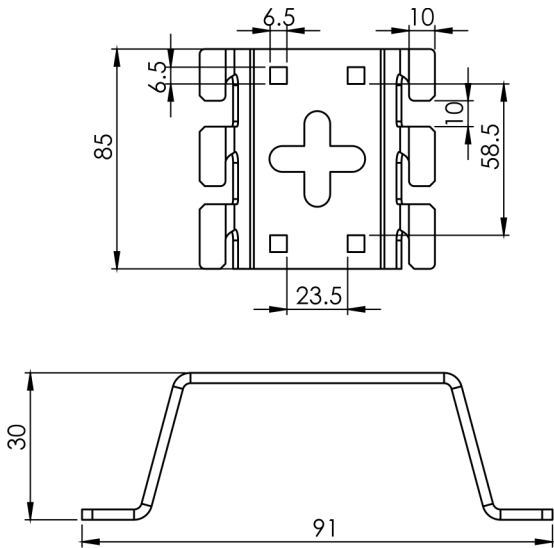

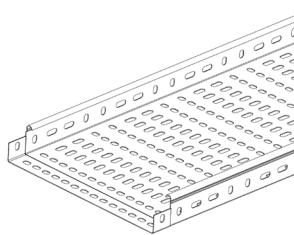

(PG) H40 Snap-On Cable

Easy Connector / No Cover Clamp / No Connection Coupler

Snap-On Cable Trays can be installed quickly. It provides economic and easy working opportunities.

Snap-On Cable Trays Cover (cap holder, bolt, screw etc.) can be connected without the need for extra connection parts.

Ergonomic operation in every assembly area with its suitable design for all cable carrying systems.

www.traycanal.com
export@traycanal.com
+90 534 598 08 65

www.traycanal.com / Cable Tray / Snap - On Cable Trays

PRODUCT CODE	HEIGHT	WIDTH	THICKNESS ± % 10	WEIGHT (KG/MT)
SO4 050 7CT P	40	50	0,70	0,630
SO4 100 7CT P	40	100	0,70	0,835
SO4 160 7CT P	40	160	0,70	1,095
SO4 200 8CT P	40	200	0,80	1,480

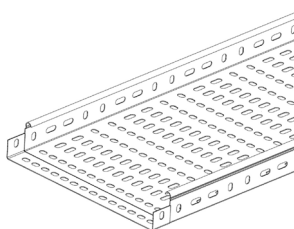

(PG) H50 Snap-On Cable

Easy Connector / No Cover Clamp / No Connection Coupler

Snap-On Cable Trays can be installed quickly. It provides economic and easy working opportunities.

Snap-On Cable Trays Cover (cap holder, bolt, screw etc.) can be connected without the need for extra connection parts.

Ergonomic operation in every assembly area with its suitable design for all cable carrying systems.

www.traycanal.com
export@traycanal.com
+90 534 598 08 65

www.traycanal.com / Cable Tray / Snap - On Cable Trays

PRODUCT CODE	HEIGHT	WIDTH	THICKNESS ± % 10	WEIGHT (KG/MT)
SO5 050 7CT P	50	50	0,70	0,715
SO5 100 7CT P	50	100	0,70	0,925
SO5 160 7CT P	50	160	0,70	1,180
SO5 200 8CT P	50	200	0,80	1,580
SO5 300 9CT P	50	300	0,90	2,380

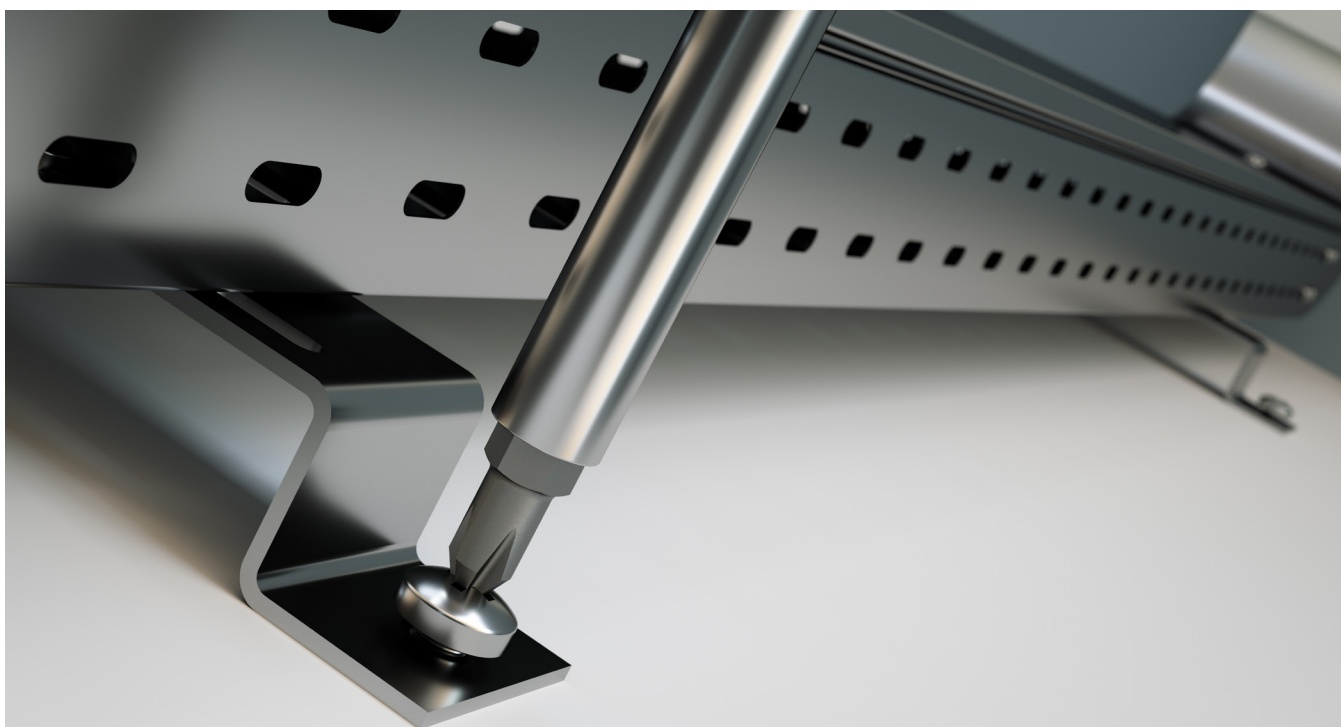

(PG) H60 Snap-On Cable

Easy Connector / No Cover Clamp / No Connection Coupler

Snap-On Cable Trays can be installed quickly. It provides economic and easy working opportunities.

Snap-On Cable Trays Cover (cap holder, bolt, screw etc.) can be connected without the need for extra connection parts.

Ergonomic operation in every assembly area with its suitable design for all cable carrying systems.

www.traycanal.com
export@traycanal.com
+90 534 598 08 65

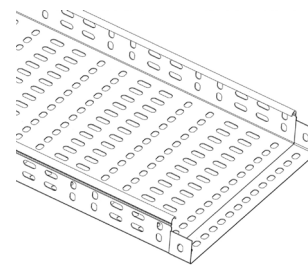

www.traycanal.com / Cable Tray / Snap - On Cable Trays

PRODUCT CODE	HEIGHT	WIDTH	THICKNESS ± % 10	WEIGHT (KG/MT)
SO6 100 7CT P	60	100	0,70	1,000
SO6 150 7CT P	60	150	0,70	1,225
SO6 200 7CT P	60	200	0,80	1,680
SO6 300 9CT P	60	300	0,90	2,500

(PG) H80 Snap-On Cable

Easy Connector / No Cover Clamp / No Connection Coupler

Snap-On Cable Trays can be installed quickly. It provides economic and easy working opportunities.

Snap-On Cable Trays Cover (cap holder, bolt, screw etc.) can be connected without the need for extra connection parts.

Ergonomic operation in every assembly area with its suitable design for all cable carrying systems.

www.traycanal.com
export@traycanal.com
+90 534 598 08 65

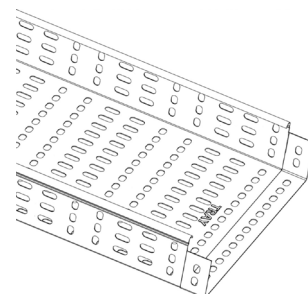

www.traycanal.com / Cable Tray / Snap - On Cable Trays

PRODUCT CODE	HEIGHT	WIDTH	THICKNESS ± % 10	WEIGHT (KG/MT)
SO8 100 8CT P	80	100	0,80	1,380
SO8 150 8CT P	80	150	0,80	1,630
SO8 200 9CT P	80	200	0,90	2,150
SO8 300 1CT P	80	300	1,00	3,060

(PG) H100 Snap-On Cable Trays

Easy Connector / No Cover Clamp / No Connection Coupler

Snap-On Cable Trays can be installed quickly. It provides economic and easy working opportunities.

Snap-On Cable Trays Cover (cap holder, bolt, screw etc.) can be connected without the need for extra connection parts.

Ergonomic operation in every assembly area with its suitable design for all cable carrying systems.

www.traycanal.com
export@traycanal.com
+90 534 598 08 65

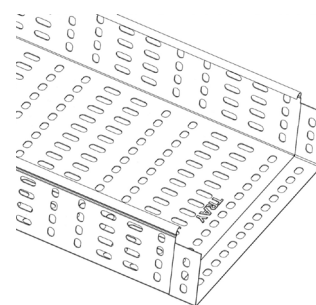

www.traycanal.com / Cable Tray / Snap - On Cable Trays

PRODUCT CODE	HEIGHT	WIDTH	THICKNESS ± % 10	WEIGHT (KG/MT)
SO1 100 8CT P	100	100	0,80	1,580
SO1 150 8CT P	100	150	0,80	1,830
SO1 200 9CT P	100	200	0,90	2,380
SO1 300 1CT P	100	300	1,00	3,325

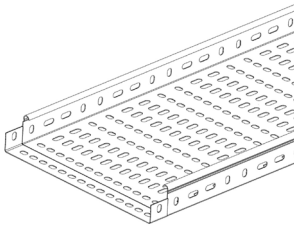

(HDG) H40 Snap-On Cable Trays

Easy Connector / No Cover Clamp / No Connection Coupler

Snap-On Cable Trays can be installed quickly. It provides economic and easy working opportunities.

Kablo Kanal Kapağı kapak tutucu, civata, vida vb. parçalara gerek olmadan bağlantı yapılabilir.

Ergonomic operation in every assembly area with its suitable design for all cable carrying systems.

www.traycanal.com
export@traycanal.com
+90 534 598 08 65

www.traycanal.com / Cable Tray / Snap - On Cable Trays

PRODUCT CODE	HEIGHT	WIDTH	THICKNESS ± % 10	WEIGHT (KG/MT)
SO4 050 8CT H	40	50	0,80	0,800
SO4 100 8CT H	40	100	0,80	1,050
SO4 160 8CT H	40	160	0,80	1,380
SO4 200 9CT H	40	200	0,90	1,820
SO4 300 1CT H	40	300	1,00	2,750
SO4 400 1CT H	40	400	1,10	3,830

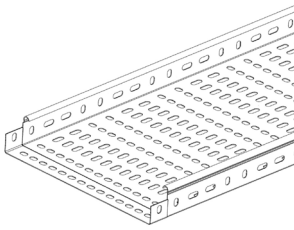

(HDG) H50 Snap-On Cable Trays

Easy Connector / No Cover Clamp / No Connection Coupler

Snap-On Cable Trays can be installed quickly. It provides economic and easy working opportunities.

Kablo Kanal Kapağı kapak tutucu, civata, vida vb. parçalara gerek olmadan bağlantı yapılabilir.

Ergonomic operation in every assembly area with its suitable design for all cable carrying systems.

www.traycanal.com
export@traycanal.com
+90 534 598 08 65

www.traycanal.com / Cable Tray / Snap - On Cable Trays

PRODUCT CODE	HEIGHT	WIDTH	THICKNESS ± % 10	WEIGHT (KG/MT)
SO5 050 8CT H	50	50	0,80	0,890
SO5 100 8CT H	50	100	0,80	1,160
SO5 160 8CT H	50	160	0,80	1,490
SO5 200 9CT H	50	200	0,90	1,950
SO5 300 1CT H	50	300	1,00	2,890
SO5 400 1CT H	50	400	1,10	3,909

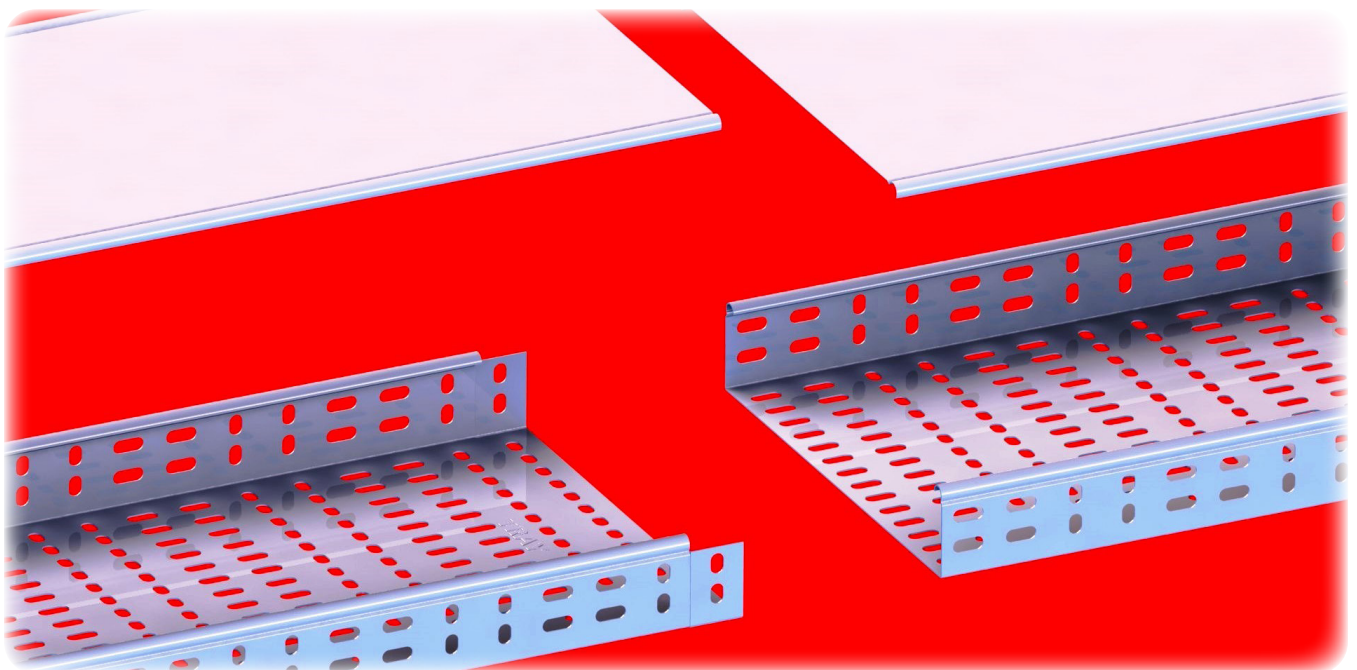

(HDG) H60 Snap-On Cable Trays

Easy Connector / No Cover Clamp / No Connection Coupler

Snap-On Cable Trays can be installed quickly. It provides economic and easy working opportunities.

Kablo Kanal Kapağı kapak tutucu,civata,vida vb. parçalara gerek olmadan bağlantı yapılabilir.

Ergonomic operation in every assembly area with its suitable design for all cable carrying systems.

www.traycanal.com
export@traycanal.com
+90 534 598 08 65

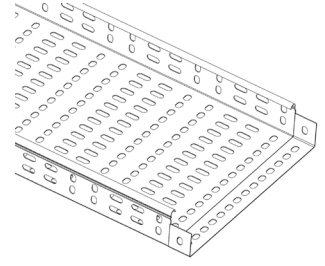

www.traycanal.com / Cable Tray / Snap - On Cable Trays

PRODUCT CODE	HEIGHT	WIDTH	THICKNESS ± % 10	WEIGHT (KG/MT)
SO6 100 8CT H	60	100	0,80	1,090
SO6 150 8CT H	60	150	0,80	1,325
SO6 200 9CT H	60	200	0,90	1,815
SO6 300 1CT H	60	300	1,00	2,700
SO6 400 1CT H	60	400	1,10	3,730

(HDG) H80 Snap-On Cable Trays

Easy Connector / No Cover Clamp / No Connection Coupler

Snap-On Cable Trays can be installed quickly. It provides economic and easy working opportunities.

Kablo Kanal Kapağı kapak tutucu,civata,vida vb. parçalara gerek olmadan bağlantı yapılabilir.

Ergonomic operation in every assembly area with its suitable design for all cable carrying systems.

www.traycanal.com
export@traycanal.com
+90 534 598 08 65

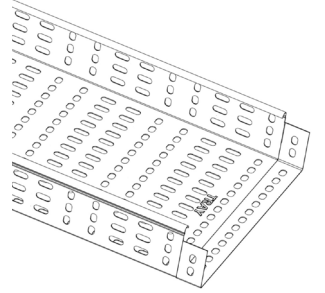

www.traycanal.com / Cable Tray / Snap - On Cable Trays

PRODUCT CODE	HEIGHT	WIDTH	THICKNESS ± % 10	WEIGHT (KG/MT)
SO8 100 9CT H	80	100	0,90	1,488
SO8 150 9CT H	80	150	0,90	1,760
SO8 200 1CT H	80	200	1,00	2,320
SO8 300 1CT H	80	300	1,10	3,310
SO8 400 2CT H	80	400	1,20	4,450

(HDG) H100 Snap-On Cable

Easy Connector / No Cover Clamp / No Connection Coupler

Snap-On Cable Trays can be installed quickly. It provides economic and easy working opportunities.

Kablo Kanal Kapağı kapak tutucu,civata,vida vb. parçalara gerek olmadan bağlantı yapılabilir.

Ergonomic operation in every assembly area with its suitable design for all cable carrying systems.

www.traycanal.com
export@traycanal.com
+90 534 598 08 65

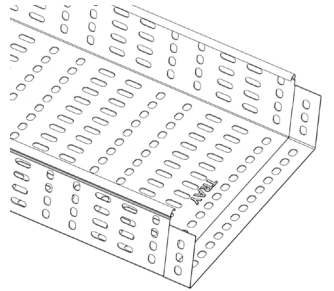

www.traycanal.com / Cable Tray / Snap - On Cable Trays

PRODUCT CODE	HEIGHT	WIDTH	THICKNESS ± % 10	WEIGHT (KG/MT)
SO1 100 9CT H	100	100	0,90	1,705
SO1 150 9CT H	100	150	0,90	1,980
SO1 200 1CT H	100	200	1,00	2,570
SO1 300 1CT H	100	300	1,10	3,590
SO1 400 2CT H	100	400	1,20	4,765

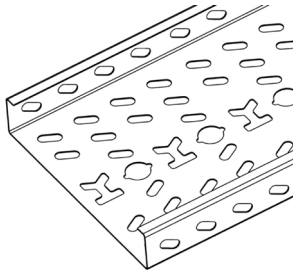

(PG) H40 Heavy Duty Cable Trays

With a width up to 1000mm / height up to 200mm.

It is possible to carry a lot of amount of cable with a width of up to 1000 mm.

Geniş kalınlık seçeneği ile aynı genişlikte esnek olarak kablo çapları seçilebilir.

Ergonomic operation in every assembly area with its suitable design for all cable carrying systems.

www.traycanal.com
export@traycanal.com
+90 534 598 08 65

www.traycanal.com / Cable Tray / PG H40 Heavy Duty Cable Trays

PRODUCT CODE	HEIGHT	WIDTH	THICKNESS \pm % 10	WEIGHT (KG/MT)
HD4 050 8CT P	40	50	0,80	0,696
HD4 100 1CT P	40	100	1,00	1,206
HD4 160 1CT P	40	160	1,00	1,579
HD4 200 1CT P	40	200	1,00	1,828
HD4 220 2CT P	40	220	1,20	2,386
HD4 260 2CT P	40	260	1,20	2,690
HD4 300 5CT P	40	300	1,50	3,810
HD4 400 5CT P	40	400	1,50	4,778
HD4 460 5CT P	40	460	1,50	5,358
HD4 500 0CT P	40	500	2,00	7,796

(HDG) H40 Heavy Duty Cable Trays

With a width up to 1000mm / height up to 200mm.

It is possible to carry a lot of amount of cable with a width of up to 1000 mm.

Geniş kalınlık seçeneği ile aynı genişlikte esnek olarak kablo çapları seçilebilir.

Ergonomic operation in every assembly area with its suitable design for all cable carrying systems.

www.traycanal.com
export@traycanal.com
+90 534 598 08 65

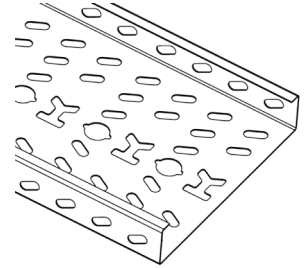

www.traycanal.com / Cable Tray / HDG H40 Heavy Duty Cable Trays

PRODUCT CODE	HEIGHT	WIDTH	THICKNESS \pm % 10	WEIGHT (KG/MT)
HD4 050 1CT H	40	50	1,00	0,859
HD4 100 2CT H	40	100	1,20	1,447
HD4 160 2CT H	40	160	1,20	1,895
HD4 200 2CT H	40	200	1,20	2,193
HD4 220 5CT H	40	220	1,50	3,045
HD4 260 5CT H	40	260	1,50	3,433
HD4 300 5CT H	40	300	1,50	3,821
HD4 400 0CT H	40	400	2,00	6,634
HD4 460 0CT H	40	460	2,00	7,440
HD4 500 0CT H	40	500	2,00	7,977

(PG) H50 Heavy Duty Cable Trays

With a width up to 1000mm / height up to 200mm.

It is possible to carry a lot of amount of cable with a width of up to 1000 mm.

Geniş kalınlık seçeneği ile aynı genişlikte esnek olarak kablo çapları seçilebilir.

Ergonomic operation in every assembly area with its suitable design for all cable carrying systems.

www.traycanal.com
export@traycanal.com
+90 534 598 08 65

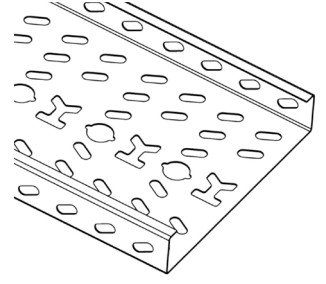

www.traycanal.com / Cable Tray / PG H50 Heavy Duty Cable Trays

PRODUCT CODE	HEIGHT	WIDTH	THICKNESS \pm % 10	WEIGHT (KG/MT)
HD5 050 8CT P	50	50	0,80	0,793
HD5 100 1CT P	50	100	1,00	1,330
HD5 160 1CT P	50	160	1,00	1,704
HD5 200 1CT P	50	200	1,00	1,952
HD5 220 2CT P	50	220	1,20	2,538
HD5 260 2CT P	50	260	1,20	2,842
HD5 300 5CT P	50	300	1,50	4,004
HD5 400 5CT P	50	400	1,50	4,971
HD5 460 5CT P	50	460	1,50	5,551
HD5 500 0CT P	50	500	2,00	8,059

(HDG) H50 Heavy Duty Cable Trays

With a width up to 1000mm / height up to 200mm.

It is possible to carry a lot of amount of cable with a width of up to 1000 mm.

Geniş kalınlık seçeneği ile aynı genişlikte esnek olarak kablo çapları seçilebilir.

Ergonomic operation in every assembly area with its suitable design for all cable carrying systems.

www.traycanal.com
export@traycanal.com
+90 534 598 08 65

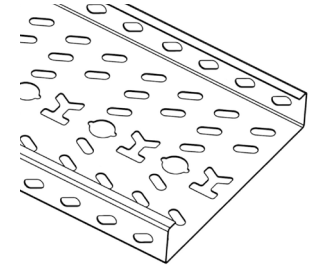

www.traycanal.com / Cable Tray / HDG H50 Heavy Duty Cable Trays

PRODUCT CODE	HEIGHT	WIDTH	THICKNESS \pm % 10	WEIGHT (KG/MT)
HD5 050 1CT H	50	50	1,00	0,979
HD5 100 2CT H	50	100	1,20	1,597
HD5 160 2CT H	50	160	1,20	2,044
HD5 200 2CT H	50	200	1,20	2,343
HD5 220 5CT H	50	220	1,50	3,239
HD5 260 5CT H	50	260	1,50	3,627
HD5 300 5CT H	50	300	1,50	4,015
HD5 400 0CT H	50	400	2,00	6,903
HD5 460 0CT H	50	460	2,00	7,708

TK506012-HDG
TK506015-HDG
TK506020-HDG

TK506010-HDG

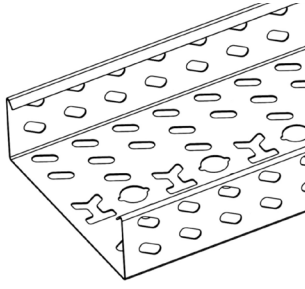

(PG) H60 Heavy Duty Cable Trays

With a width up to 1000mm / height up to 200mm.

It is possible to carry a lot of amount of cable with a width of up to 1000 mm.

Geniş kalınlık seçeneği ile aynı genişlikte esnek olarak kablo çapları seçilebilir.

Ergonomic operation in every assembly area with its suitable design for all cable carrying systems.

www.traycanal.com
export@traycanal.com
+90 534 598 08 65

www.traycanal.com / Cable Tray / PG H60 Heavy Duty Cable Trays

PRODUCT CODE	HEIGHT	WIDTH	THICKNESS \pm % 10	WEIGHT (KG/MT)
HD6 100 8CT P	60	100	0,80	1,132
HD6 160 1CT P	60	160	1,00	1,828
HD6 200 1CT P	60	200	1,00	2,077
HD6 220 2CT P	60	220	1,20	2,690
HD6 260 2CT P	60	260	1,20	2,994
HD6 300 5CT P	60	300	1,50	4,197
HD6 400 5CT P	60	400	1,50	5,164
HD6 460 0CT P	60	460	2,00	7,796
HD6 500 0CT P	60	500	2,00	8,321

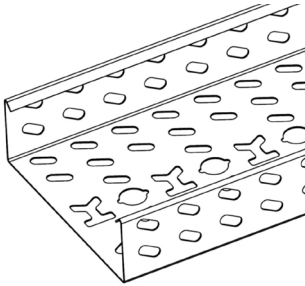

(HDG) H60 Heavy Duty Cable Trays

With a width up to 1000mm / height up to 200mm.

It is possible to carry a lot of amount of cable with a width of up to 1000 mm.

Geniş kalınlık seçeneği ile aynı genişlikte esnek olarak kablo çapları seçilebilir.

Ergonomic operation in every assembly area with its suitable design for all cable carrying systems.

www.traycanal.com
export@traycanal.com
+90 534 598 08 65

www.traycanal.com / Cable Tray / HDG H60 Heavy Duty Cable Trays

PRODUCT CODE	HEIGHT	WIDTH	THICKNESS \pm % 10	WEIGHT (KG/MT)
HD6 100 1CT H	60	100	1,00	1,397
HD6 160 2CT H	60	160	1,20	2,193
HD6 200 2CT H	60	200	1,20	2,492
HD6 220 2CT H	60	220	1,20	2,641
HD6 260 2CT H	60	260	1,20	2,939
HD6 300 5CT H	60	300	1,50	4,209
HD6 400 5CT H	60	400	1,50	5,179
HD6 460 0CT H	60	460	2,00	7,977
HD6 500 0CT H	60	500	2,00	8,514

(PG) H80 Heavy Duty Cable Trays

With a width up to 1000mm / height up to 200mm.

It is possible to carry a lot of amount of cable with a width of up to 1000 mm.

Geniş kalınlık seçeneği ile aynı genişlikte esnek olarak kablo çapları seçilebilir.

Ergonomic operation in every assembly area with its suitable design for all cable carrying systems.

www.traycanal.com
export@traycanal.com
+90 534 598 08 65

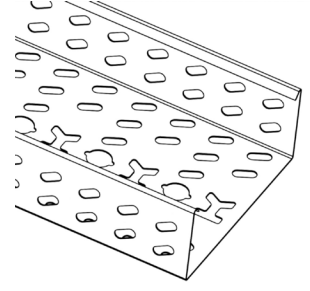

www.traycanal.com / Cable Tray / PG H80 Heavy Duty Cable Trays

PRODUCT CODE	HEIGHT	WIDTH	THICKNESS ± % 10	WEIGHT (KG/MT)
HD8 100 8CT P	80	100	0,80	1,325
HD8 160 1CT P	80	160	1,00	2,077
HD8 200 1CT P	80	200	1,00	2,325
HD8 220 2CT P	80	220	1,20	2,994
HD8 260 2CT P	80	260	1,20	3,298
HD8 300 5CT P	80	300	1,50	4,584
HD8 400 5CT P	80	400	1,50	5,551
HD8 460 0CT P	80	460	2,00	8,321
HD8 500 0CT P	80	500	2,00	8,846

(HDG) H80 Heavy Duty Cable Trays

With a width up to 1000mm / height up to 200mm.

It is possible to carry a lot of amount of cable with a width of up to 1000 mm.

Geniş kalınlık seçeneği ile aynı genişlikte esnek olarak kablo çapları seçilebilir.

Ergonomic operation in every assembly area with its suitable design for all cable carrying systems.

www.traycanal.com
export@traycanal.com
+90 534 598 08 65

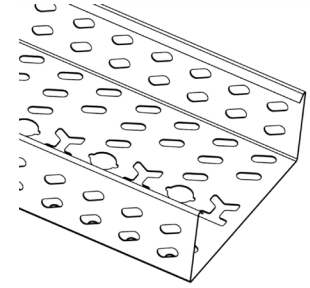

www.traycanal.com / Cable Tray / HDG H80 Heavy Duty Cable Trays

PRODUCT CODE	HEIGHT	WIDTH	THICKNESS ± % 10	WEIGHT (KG/MT)
HD8 100 1CT H	80	100	1,00	1,635
HD8 160 2CT H	80	160	1,20	2,492
HD8 200 2CT H	80	200	1,20	2,790
HD8 220 2CT H	80	220	1,20	2,939
HD8 260 2CT H	80	260	1,20	3,238
HD8 300 5CT H	80	300	1,50	4,597
HD8 400 5CT H	80	400	1,50	5,567
HD8 460 0CT H	80	460	2,00	8,514
HD8 500 0CT H	80	500	2,00	9,051

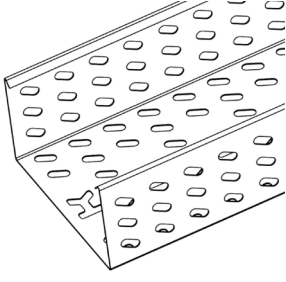

(PG) H100 Heavy Duty Cable Trays

With a width up to 1000mm / height up to 200mm.

It is possible to carry a lot of amount of cable with a width of up to 1000 mm.

Geniş kalınlık seçeneği ile aynı genişlikte esnek olarak kablo çapları seçilebilir.

Ergonomic operation in every assembly area with its suitable design for all cable carrying systems.

www.traycanal.com
export@traycanal.com
+90 534 598 08 65

www.traycanal.com / Cable Tray / PG H100 Heavy Duty Cable Trays

PRODUCT CODE	HEIGHT	WIDTH	THICKNESS \pm % 10	WEIGHT (KG/MT)
HD1 100 8CT P	100	100	0,80	1,518
HD1 160 1CT P	100	160	1,00	2,325
HD1 200 1CT P	100	200	1,00	2,574
HD1 220 2CT P	100	220	1,20	3,298
HD1 260 2CT P	100	260	1,20	3,602
HD1 300 5CT P	100	300	1,50	4,971
HD1 400 5CT P	100	400	1,50	5,938
HD1 460 0CT P	100	460	2,00	8,846
HD1 500 0CT P	100	500	2,00	9,371

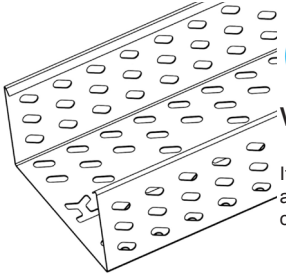

(HDG) H100 Heavy Duty Cable Trays

With a width up to 1000mm / height up to 200mm.

It is possible to carry a lot of amount of cable with a width of up to 1000 mm.

Geniş kalınlık seçeneği ile aynı genişlikte esnek olarak kablo çapları seçilebilir.

Ergonomic operation in every assembly area with its suitable design for all cable carrying systems.

www.traycanal.com
export@traycanal.com
+90 534 598 08 65

www.traycanal.com / Cable Tray / HDG H100 Heavy Duty Cable Trays

PRODUCT CODE	HEIGHT	WIDTH	THICKNESS \pm % 10	WEIGHT (KG/MT)
HD1 100 1CT H	100	100	1,00	1,874
HD1 160 2CT H	100	160	1,20	2,790
HD1 200 2CT H	100	200	1,20	3,089
HD1 220 2CT H	100	220	1,20	3,238
HD1 260 2CT H	100	260	1,20	3,536
HD1 300 5CT H	100	300	1,50	4,985
HD1 400 5CT H	100	400	1,50	5,955
HD1 460 0CT H	100	460	2,00	9,051
HD1 500 0CT H	100	500	2,00	9,588

(H40/50/60/80/100 PG / H.D.G./SS304)

Connection Parts

With a width up to 1000 mm / height up to 200 mm.

This product is used by fixing it to the Cable Tray with M8x15 Bolt / Nut.

Ergonomic operation in every assembly area with its suitable design for all cable carrying systems.

www.traycanal.com
export@traycanal.com
+90 534 598 08 65

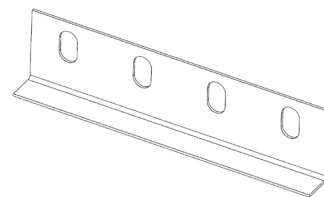

www.traycanal.com / H50 Connection Parts

PRODUCT CODE	HEIGHT	WIDTH	THICKNESS ± % 10	WEIGHT (KG/PCS)
CLC5 140 12 P	40/50/60/80/100	140	1,2	0,069
CLC5 210 12 P	40/50/60/80/100	210	1,2	0,103
CLC5 140 15 H	40/50/60/80/100	140	1,5	0,092
CLC5 210 15 H	40/50/60/80/100	210	1,5	0,138

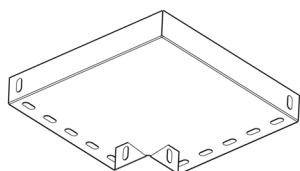

(P.G. / HDG / SS304) H40/50/60/80/100 Heavy Duty Cable Tray 90° Bends

With a width up to 1000 mm / height up to 200 mm.

It is possible to carry a lot of amount of cable with a width of up to 1000 mm.

Ergonomic operation in every assembly area with its suitable design for all cable carrying systems.

www.traycanal.com
export@traycanal.com
+90 534 598 08 65

www.traycanal.com / Cable Tray / PG H50 Heavy Duty Cable Tray 90° Bends

PRODUCT CODE	HEIGHT	WIDTH	THICKNESS ± % 10	WEIGHT (KG/PCS)
HD5 050 LB P	40/50/60/80/100	50	0,80	0,162
HD5 100 LB P	40/50/60/80/100	100	1,00	0,345
HD5 160 LB P	40/50/60/80/100	160	1,00	0,564
HD5 200 LB P	40/50/60/80/100	200	1,00	0,740
HD5 220 LB P	40/50/60/80/100	220	1,20	1,004
HD5 260 LB P	40/50/60/80/100	260	1,20	1,258
HD5 300 LB P	40/50/60/80/100	300	1,20	1,541
HD5 400 LB P	40/50/60/80/100	400	1,50	2,967
HD5 460 LB P	40/50/60/80/100	460	1,50	3,698
HD5 500 LB P	40/50/60/80/100	500	2,00	5,641
HD5 600 LB P	40/50/60/80/100	600	2,00	7,625

(P.G. / HDG) H40/50/60/80/100 Heavy Duty Cable Tray Tee Bends

With a width up to 1000 mm / height up to 200 mm.

It is possible to carry a lot of amount of cable with a width of up to 1000 mm.

Ergonomic operation in every assembly area with its suitable design for all cable carrying systems.

www.traycanal.com
export@traycanal.com
+90 534 598 08 65

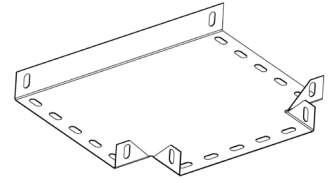

www.traycanal.com / Cable Tray / PG H50 Heavy Duty Cable Tray Tee Bends

PRODUCT CODE	HEIGHT	WIDTH	THICKNESS ± % 10	WEIGHT (KG/PCS)
HD5 050 TB P	50	50	0,80	0,177
HD5 100 TB P	50	100	1,00	0,369
HD5 160 TB P	50	160	1,00	0,595
HD5 200 TB P	50	200	1,00	0,775
HD5 220 TB P	50	220	1,20	1,049
HD5 260 TB P	50	260	1,20	1,309
HD5 300 TB P	50	300	1,20	1,597
HD5 400 TB P	50	400	1,50	3,053
HD5 460 TB P	50	460	1,50	3,795
HD5 500 TB P	50	500	2,00	5,779

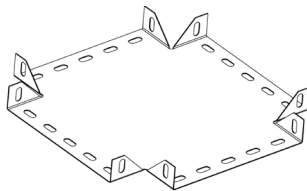

(P.G. / HDG) H40/50/60/80/100 Heavy Duty Cable Tray Four Way Bends

With a width up to 1000 mm / height up to 200 mm.

It is possible to carry a lot of amount of cable with a width of up to 1000 mm.

Ergonomic operation in every assembly area with its suitable design for all cable carrying systems.

www.traycanal.com
export@traycanal.com
+90 534 598 08 65

www.traycanal.com / Cable Tray / PG H50 Heavy Duty Cable Tray Four Way Bends

PRODUCT CODE	HEIGHT	WIDTH	THICKNESS ± % 10	WEIGHT (KG/PCS)
HD5 050 FB P	50	50	0,80	0,193
HD5 100 FB P	50	100	1,00	0,395
HD5 160 FB P	50	160	1,00	0,627
HD5 200 FB P	50	200	1,00	0,812
HD5 220 FB P	50	220	1,20	1,096
HD5 260 FB P	50	260	1,20	1,361
HD5 300 FB P	50	300	1,20	1,655
HD5 400 FB P	50	400	1,50	3,142
HD5 460 FB P	50	460	1,50	3,894
HD5 500 FB P	50	500	2,00	5,920

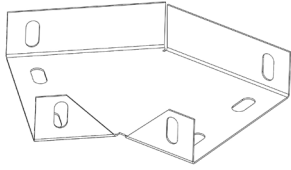

(P.G. / HDG) H40/50/60/80/100 Heavy Duty Cable Tray 45° Bends

With a width up to 1000 mm / height up to 200 mm.

It is possible to carry a lot of amount of cable with a width of up to 1000 mm.

Ergonomic operation in every assembly area with its suitable design for all cable carrying systems.

www.traycanal.com
export@traycanal.com
+90 534 598 08 65

www.traycanal.com / Cable Tray / PG H50 Heavy Duty Cable Tray 45° Bends

PRODUCT CODE	HEIGHT	WIDTH	THICKNESS ± % 10	WEIGHT (KG/PCS)
HD5 050 4B P	50	50	0,80	0,126
HD5 100 4B P	50	100	1,00	0,282
HD5 160 4B P	50	160	1,00	0,479
HD5 200 4B P	50	200	1,00	0,617
HD5 220 4B P	50	220	1,20	0,832
HD5 260 4B P	50	260	1,20	1,092
HD5 300 4B P	50	300	1,20	1,300
HD5 400 4B P	50	400	1,50	2,519
HD5 460 4B P	50	460	1,50	3,124
HD5 500 4B P	50	500	2,00	4,810

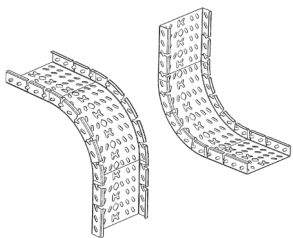

(P.G. / HDG) H40/50/60/80/100 Inside / Outside 90° Bends

With a width up to 1000 mm / height up to 200 mm.

It is possible to carry a lot of amount of cable with a width of up to 1000 mm.

Ergonomic operation in every assembly area with its suitable design for all cable carrying systems.

www.traycanal.com
export@traycanal.com
+90 534 598 08 65

www.traycanal.com / Cable Tray / PG H50 Inside / Outside 90° Bends (Adjustable)

PRODUCT CODE	HEIGHT	WIDTH	THICKNESS ± % 10	WEIGHT (KG/PCS)
HD5 050 IO P	50	50	1,00	0,714
HD5 100 IO P	50	100	1,00	0,932
HD5 160 IO P	50	160	1,00	1,193
HD5 200 IO P	50	200	1,20	1,672
HD5 220 IO P	50	220	1,20	1,778
HD5 260 IO P	50	260	1,20	1,991
HD5 300 IO P	50	300	1,20	2,204
HD5 400 IO P	50	400	1,50	3,483
HD5 460 IO P	50	450	1,50	3,821
HD5 500 IO P	50	500	2,00	5,646

(P.G. / HDG) H40/50/60/80/100 Inside 90° Bends (Fixed)

With a width up to 1000 mm / height up to 200 mm.

It is possible to carry a lot of amount of cable with a width of up to 1000 mm.

Ergonomic operation in every assembly area with its suitable design for all cable carrying systems.

www.traycanal.com
export@traycanal.com
+90 534 598 08 65

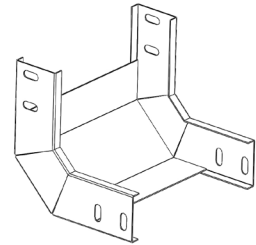

www.traycanal.com / Cable Tray / PG H50 Inside 90° Bends (Fixed)

PRODUCT CODE	HEIGHT	WIDTH	THICKNESS ± % 10	WEIGHT (KG/PCS)
HD5 050 IV P	50	50	1,20	0,398
HD5 100 IV P	50	100	1,20	0,452
HD5 160 IV P	50	160	1,20	0,516
HD5 200 IV P	50	200	1,20	0,559
HD5 220 IV P	50	220	1,20	0,581
HD5 260 IV P	50	260	1,20	0,624
HD5 300 IV P	50	300	1,20	0,667
HD5 400 IV P	50	400	1,50	0,968
HD5 460 IV P	50	450	1,50	1,035
HD5 500 IV P	50	500	2,00	1,469

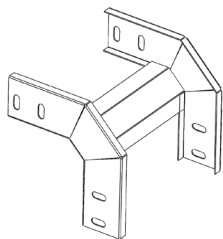

(P.G. / HDG) H40/50/60/80/100 Outside Bends (Fixed)

With a width up to 1000 mm / height up to 200 mm.

It is possible to carry a lot of amount of cable with a width of up to 1000 mm.

Ergonomic operation in every assembly area with its suitable design for all cable carrying systems.

www.traycanal.com
export@traycanal.com
+90 534 598 08 65

www.traycanal.com / Cable Tray / PG H50 Outside 90° Bends (Fixed)

PRODUCT CODE	HEIGHT	WIDTH	THICKNESS ± % 10	WEIGHT (KG/PCS)
HD5 050 OV P	50	50	1,20	0,380
HD5 100 OV P	50	100	1,20	0,416
HD5 160 OV P	50	160	1,20	0,459
HD5 200 OV P	50	200	1,20	0,488
HD5 220 OV P	50	220	1,20	0,502
HD5 260 OV P	50	260	1,20	0,531
HD5 300 OV P	50	300	1,20	0,559
HD5 400 OV P	50	400	1,50	0,789
HD5 460 OV P	50	450	1,50	0,833
HD5 500 OV P	50	500	2,00	1,171

(P.G. / HDG) H40/50/60/80/100 Vertical Tees

With a width up to 1000 mm / height up to 200 mm.

It is possible to carry a lot of amount of cable with a width of up to 1000 mm.

Ergonomic operation in every assembly area with its suitable design for all cable carrying systems.

www.traycanal.com
export@traycanal.com
+90 534 598 08 65

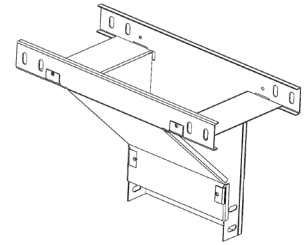

www.traycanal.com / Cable Tray / PG H50 Vertical Tees

PRODUCT CODE	HEIGHT	WIDTH	THICKNESS ± % 10	WEIGHT (KG/PCS)
HD5 050 VT P	50	50	1,5	4,531
HD5 100 VT P	50	100	1,5	4,866
HD5 160 VT P	50	160	1,5	5,191
HD5 200 VT P	50	200	1,5	5,516
HD5 220 VT P	50	220	1,5	5,679
HD5 260 VT P	50	260	1,5	5,841
HD5 300 VT P	50	300	1,5	6,166
HD5 400 VT P	50	400	2,0	8,698
HD5 460 VT P	50	460	2,0	9,088
HD5 500 VT P	50	500	2,0	9,478

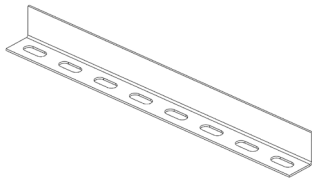

(P.G. / HDG) Separators

With a width up to 1000 mm / height up to 200 mm.

It is possible to carry a lot of amount of cable with a width of up to 1000 mm.

Ergonomic operation in every assembly area with its suitable design for all cable carrying systems.

www.traycanal.com
export@traycanal.com
+90 534 598 08 65

www.traycanal.com / Cable Tray / PG Separators

PRODUCT CODE	HEIGHT	LENGHT	THICKNESS ± % 10	WEIGHT (KG/MT)
HD4 SP2 P	40	1500	1,2	0,528
HD4 SP5 P	40	1500	1,5	0,671
HD5 SP2 P	50	1500	1,2	0,609
HD5 SP5 P	50	1500	1,5	0,775
HD6 SP2 P	60	1500	1,2	0,690
HD6 SP5 P	60	1500	1,5	0,878
HD8 SP2 P	80	1500	1,2	0,852
HD8 SP5 P	80	1500	1,5	1,085
HD1 SP2 P	100	1500	1,2	1,015

(P.G. / HDG) H40/50/60/80/100 Reducing Angles

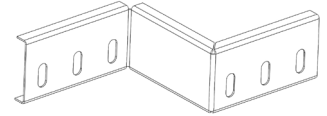

With a width up to 1000 mm / height up to 200 mm.

It is possible to carry a lot of amount of cable with a width of up to 1000 mm.

Ergonomic operation in every assembly area with its suitable design for all cable carrying systems.

www.traycanal.com
export@traycanal.com
+90 534 598 08 65

www.traycanal.com / Cable Tray / PG H50 Reducing Angles Fixing Bends

PRODUCT CODE	HEIGHT	WIDTH	THICKNESS ± % 10	WEIGHT (KG/PCS)
RA5 050 P	50	50	1,5	0,149
RA5 100 P	50	100	1,5	0,188
RA5 160 P	50	160	1,5	0,235
RA5 200 P	50	200	1,5	0,266
RA5 220 P	50	220	1,5	0,282
RA5 260 P	50	160	1,5	0,235
RA5 300 P	50	300	1,5	0,345
RA5 400 P	50	400	2,0	0,564
RA5 460 P	50	460	2,0	0,626
RA5 500 P	50	500	2,0	0,668

RESIM

(P.G. / H.D.G.) Vertical Angle Connectors

With a width up to 1000 mm / height up to 200 mm.

It is possible to carry a lot of amount of cable with a width of up to 1000 mm.

Ergonomic operation in every assembly area with its suitable design for all cable carrying systems.

www.traycanal.com
export@traycanal.com
+90 534 598 08 65

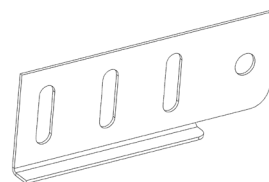

www.traycanal.com / Cable Tray / PG H100 Reducing Angles

PRODUCT CODE	HEIGHT	WIDTH	THICKNESS ± % 10	WEIGHT (KG/PCS)
VAC 040 P	40	140	1,5	0,089
VAC 050 P	50	140	1,5	0,107
VAC 060 P	60	140	1,5	0,125
VAC 080 P	80	140	1,5	0,161
VAC 100 P	100	140	1,5	0,197
VAC 040 H	40	140	1,5	0,100
VAC 050 H	50	140	1,5	0,120
VAC 060 H	60	140	1,5	0,140
VAC 080 H	80	140	1,5	0,180

TK260100020-PG

(P.G. / H.D.G.) Horizontal Angle Connectors

With a width up to 1000 mm / height up to 200 mm.

It is possible to carry a lot of amount of cable with a width of up to 1000 mm.

Ergonomic operation in every assembly area with its suitable design for all cable carrying systems.

www.traycanal.com
export@traycanal.com
+90 534 598 08 65

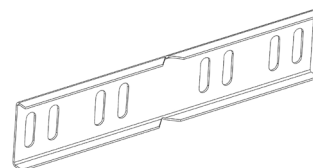

www.traycanal.com / Cable Tray / HDG H100 Reducing Angles

PRODUCT CODE	HEIGHT	WIDTH	THICKNESS ± % 10	WEIGHT (KG/PCS)
HAC 040 P	40	210	1,5	0,117
HAC 050 P	50	210	1,5	0,141
HAC 060 P	60	210	1,5	0,164
HAC 080 P	80	210	1,5	0,211
HAC 100 P	100	210	1,5	0,258
HAC 040 H	40	210	1,5	0,131
HAC 050 H	50	210	1,5	0,157
HAC 060 H	60	210	1,5	0,183
HAC 080 H	80	210	1,5	0,236

TK260100020-HDG

(H40/50/60/70/80/100 P.G. / HDG)

Cable Ladder

With a width up to 1000 mm / height up to 200 mm.

It is possible to carry a lot of amount of cable with a width of up to 1000 mm.

Ergonomic operation in every assembly area with its suitable design for all cable carrying systems.

www.traycanal.com
export@traycanal.com
+90 534 598 08 65

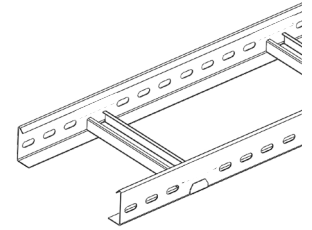

www.traycanal.com / Cable Tray / H50 PG Cable Ladder

PRODUCT CODE	HEIGHT	WIDTH	THICKNESS ± % 10	WEIGHT (KG/MT)
CL5 100 2CL P	50	100	1,2	1,567
CL5 200 2CL P	50	200	1,2	1,720
CL5 300 2CL P	50	300	1,2	1,874
CL5 400 5CL P	50	400	1,5	2,564
CL5 500 5CL P	50	500	1,5	2,755
CL5 600 5CL P	50	600	1,5	2,947

(H40/50/60/70/80/100 P.G. /HDG)

Cable Ladder 90° Bends

With a width up to 1000 mm / height up to 200 mm.

It is possible to carry a lot of amount of cable with a width of up to 1000 mm.

Ergonomic operation in every assembly area with its suitable design for all cable carrying systems.

www.traycanal.com
export@traycanal.com
+90 534 598 08 65

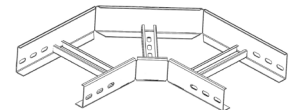

www.traycanal.com / Cable Ladder / H50 PG Cable Ladder Bends

PRODUCT CODE	HEIGHT	WIDTH	THICKNESS ± % 10	WEIGHT (KG/PCS)
CL5 100 LB P	50	100	1,2	0,890
CL5 200 LB P	50	200	1,2	1,139
CL5 300 LB P	50	300	1,2	1,389
CL5 400 LB P	50	400	1,2	1,786
CL5 500 LB P	50	500	1,2	2,068
CL5 600 LB P	50	600	1,2	2,350

(H40/50/60/70/80/100 P.G. / HDG)

Cable Ladder Tee Bends

With a width up to 1000 mm / height up to 200 mm.

It is possible to carry a lot of amount of cable with a width of up to 1000 mm.

Ergonomic operation in every assembly area with its suitable design for all cable carrying systems.

www.traycanal.com
export@traycanal.com
+90 534 598 08 65

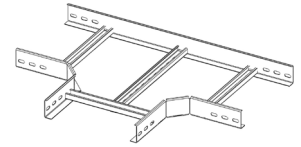

www.traycanal.com / Cable Ladder / H50 PG Cable Ladder Bends

PRODUCT CODE	HEIGHT	WIDTH	THICKNESS ± % 10	WEIGHT (KG/PCS)
CL4 100 TB P	40	100	1,2	1,040
CL4 200 TB P	40	200	1,2	1,234
CL4 300 TB P	40	300	1,2	1,428
CL4 400 TB P	40	400	1,2	1,768
CL4 500 TB P	40	500	1,2	2,291
CL4 600 TB P	40	600	1,2	2,572

(H40/50/60/70/80/100 P.G. / HDG)

Cable Ladder Four Way Bends

With a width up to 1000 mm / height up to 200 mm.

It is possible to carry a lot of amount of cable with a width of up to 1000 mm.

Ergonomic operation in every assembly area with its suitable design for all cable carrying systems.

www.traycanal.com
export@traycanal.com
+90 534 598 08 65

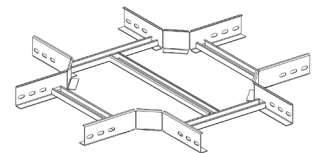

www.traycanal.com / Cable Ladder / H50 PG Cable Ladder Bends

PRODUCT CODE	HEIGHT	WIDTH	THICKNESS ± % 10	WEIGHT (KG/PCS)
CL5 100 FB P	50	100	1,2	1,351
CL5 200 FB P	50	200	1,2	1,482
CL5 300 FB P	50	300	1,2	1,612
CL5 400 FB P	50	400	1,2	1,888
CL5 500 FB P	50	500	1,2	2,348
CL5 600 FB P	50	600	1,2	2,565

(H40/50/60/70/80/100 P.G. / HDG)

Cable Ladder 45° Way Bends

With a width up to 1000 mm / height up to 200 mm.

It is possible to carry a lot of amount of cable with a width of up to 1000 mm.

Ergonomic operation in every assembly area with its suitable design for all cable carrying systems.

www.traycanal.com
export@traycanal.com
+90 534 598 08 65

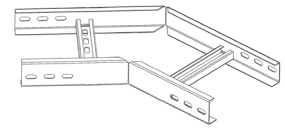

www.traycanal.com / Cable Ladder / H50 PG Cable Ladder Bends

PRODUCT CODE	HEIGHT	WIDTH	THICKNESS ± % 10	WEIGHT (KG/PCS)
CL5 100 4B P	50	100	1,2	0,860
CL5 200 4B P	50	200	1,2	1,101
CL5 300 4B P	50	300	1,2	1,343
CL5 400 4B P	50	400	1,2	1,726
CL5 500 4B P	50	500	1,2	1,999
CL5 600 4B P	50	600	1,2	2,271

(H40/50/60/70/80/100 P.G. / HDG)

Inside / Outside 90° Bends (Adjustable)

With a width up to 1000 mm / height up to 200 mm.

It is possible to carry a lot of amount of cable with a width of up to 1000 mm.

Ergonomic operation in every assembly area with its suitable design for all cable carrying systems.

www.traycanal.com
export@traycanal.com
+90 534 598 08 65

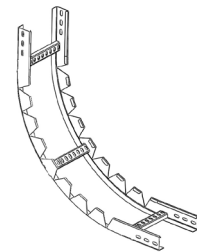

www.traycanal.com / Cable Ladder / Inside / Outside 90° Bends (Adjustable)

PRODUCT CODE	HEIGHT	WIDTH	THICKNESS ± % 10	WEIGHT (KG/PCS)
CL5 100 IO P	50	100	1,2	1,485
CL5 200 IO P	50	200	1,2	1,630
CL5 300 IO P	50	300	1,2	1,775
CL5 400 IO P	50	400	1,5	2,429
CL5 500 IO P	50	500	1,5	2,610
CL5 600 IO P	50	600	1,5	2,792

(H40/50/60/70/80/100 P.G. / HDG)

Inside 90° Bends (Fixed)

With a width up to 1000 mm / height up to 200 mm.

It is possible to carry a lot of amount of cable with a width of up to 1000 mm.

Ergonomic operation in every assembly area with its suitable design for all cable carrying systems.

www.traycanal.com
export@traycanal.com
+90 534 598 08 65

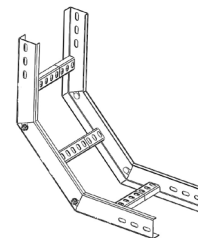

www.traycanal.com / Cable Ladder / Inside 90° Bends (Fixed)

PRODUCT CODE	HEIGHT	WIDTH	THICKNESS ± % 10	WEIGHT (KG/PCS)
CL5 100 IV P	50	100	1,2	1,121
CL5 200 IV P	50	200	1,2	1,259
CL5 300 IV P	50	300	1,2	1,388
CL5 400 IV P	50	400	1,2	1,669
CL5 500 IV P	50	500	1,2	1,839
CL5 600 IV P	50	600	1,2	2,005

(H40/50/60/70/80/100 P.G. / HDG)

Outside 90° Bends (Fixed)

With a width up to 1000 mm / height up to 200 mm.

It is possible to carry a lot of amount of cable with a width of up to 1000 mm.

Ergonomic operation in every assembly area with its suitable design for all cable carrying systems.

www.traycanal.com
export@traycanal.com
+90 534 598 08 65

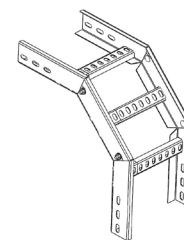

www.traycanal.com / Cable Ladder / Outside 90° Bends (Fixed)

PRODUCT CODE	HEIGHT	WIDTH	THICKNESS ± % 10	WEIGHT (KG/PCS)
CL5 100 OV P	50	100	1,2	1,097
CL5 200 OV P	50	200	1,2	1,232
CL5 300 OV P	50	300	1,2	1,358
CL5 400 OV P	50	400	1,2	1,632
CL5 500 OV P	50	500	1,2	1,799
CL5 600 OV P	50	600	1,2	1,961

(H40/50/60/70/80/100 P.G. / HDG)

Level Change Units

With a width up to 1000 mm / height up to 200 mm.

It is possible to carry a lot of amount of cable with a width of up to 1000 mm.

Ergonomic operation in every assembly area with its suitable design for all cable carrying systems.

www.traycanal.com
export@traycanal.com
+90 534 598 08 65

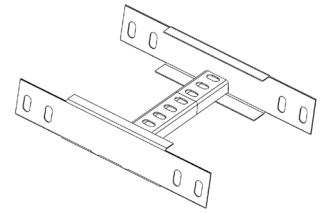

www.traycanal.com / Cable Ladder / H50 Level Change Units (PG)

PRODUCT CODE	HEIGHT	WIDTH	THICKNESS ± % 10	WEIGHT (KG/PCS)
CL5 100 LC P	50	100	1,5	0,502
CL5 200 LC P	50	200	1,5	0,546
CL5 300 LC P	50	300	1,5	0,586
CL5 400 LC P	50	400	1,5	0,678
CL5 500 LC P	50	500	1,5	0,731
CL5 600 LC P	50	600	1,5	0,784

(H40/50/60/70/80/100 P.G. / HDG)

Vertical Tees

With a width up to 1000 mm / height up to 200 mm.

It is possible to carry a lot of amount of cable with a width of up to 1000 mm.

Ergonomic operation in every assembly area with its suitable design for all cable carrying systems.

www.traycanal.com
export@traycanal.com
+90 534 598 08 65

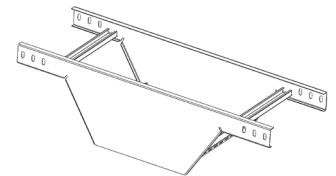

www.traycanal.com / Cable Ladder / H50 Vertical Tees (PG)

PRODUCT CODE	HEIGHT	WIDTH	THICKNESS ± % 10	WEIGHT (KG/PCS)
CL5 100 VT P	50	100	1,5	4,866
CL5 200 VT P	50	200	1,5	5,516
CL5 300 VT P	50	300	1,5	6,166
CL5 400 VT P	50	400	2	8,698
CL5 500 VT P	50	500	2	9,478
CL5 600 VT P	50	600	2	10,258

(H40/50/60/70/80/100 P.G. / HDG)

From Middle Tees

With a width up to 1000 mm / height up to 200 mm.

It is possible to carry a lot of amount of cable with a width of up to 1000 mm.

Ergonomic operation in every assembly area with its suitable design for all cable carrying systems.

www.traycanal.com
export@traycanal.com
+90 534 598 08 65

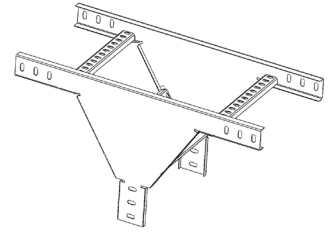

www.traycanal.com / Cable Ladder / H50 From Middle Tees (HDG)

PRODUCT CODE	HEIGHT	WIDTH	THICKNESS ± % 10	WEIGHT (KG/PCS)
CL5 100 FT P	50	100	1,5	3,044
CL5 200 FT P	50	200	1,5	4,548
CL5 300 FT P	50	300	1,5	6,218
CL5 400 FT P	50	400	2	10,686
CL5 500 FT P	50	500	2	13,645
CL5 600 FT P	50	600	2	16,894

(H40/50/60/70/80/100 P.G. / HDG)

Seperators

With a width up to 1000 mm / height up to 200 mm.

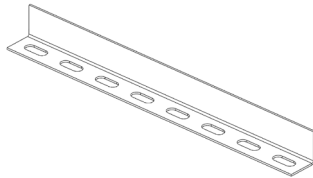

It is possible to carry a lot of amount of cable with a width of up to 1000 mm.

Ergonomic operation in every assembly area with its suitable design for all cable carrying systems.

www.traycanal.com
export@traycanal.com
+90 534 598 08 65

www.traycanal.com / Cable Ladder / PG Seperators

PRODUCT CODE	HEIGHT	LENGHT	THICKNESS ± % 10	WEIGHT (KG/MT)
CL4 SP5 P	22	1500	1,5	0,528
CL5 SP5 P	32	1500	1,5	0,671
CL6 SP5 P	42	1500	1,5	0,609
CL7 SP5 P	52	1500	1,5	0,775
CL1 SP5 P	82	1500	1,5	0,690

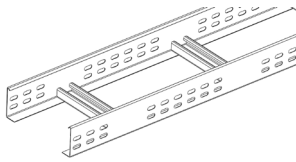

(H70/100/125/150 P.G / H.D.G.)

Welded Cable Ladder (C Rungs)

With a width up to 1000 mm / height up to 200 mm.

It is possible to carry a lot of amount of cable with a width of up to 1000 mm.

Ergonomic operation in every assembly area with its suitable design for all cable carrying systems.

www.traycanal.com
export@traycanal.com
+90 534 598 08 65

www.traycanal.com / Cable Tray / H70 HDG Welded Cable Ladder (C Rungs)

PRODUCT CODE	HEIGHT	WIDTH	THICKNESS ± % 10	WEIGHT (KG/MT)
CC7 100 CL5 H	70	100	1,5	2,203
CC7 200 CL5 H	70	200	1,5	2,504
CC7 300 CL5 H	70	300	1,5	2,806
CC7 400 CL0 H	70	400	2,0	3,792
CC7 500 CL0 H	70	500	2,0	4,093
CC7 600 CL0 H	70	600	2,0	4,395

(H70/100/125/150 P.G / H.D.G.)

Welded Cable Ladder (C Rungs) 90° Bends

With a width up to 1000 mm / height up to 200 mm.

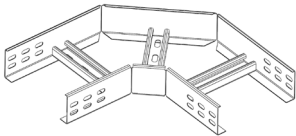

It is possible to carry a lot of amount of cable with a width of up to 1000 mm.

Ergonomic operation in every assembly area with its suitable design for all cable carrying systems.

www.traycanal.com
export@traycanal.com
+90 534 598 08 65

www.traycanal.com / Welded Cable Ladder / H70 HDG Welded Cable Ladder (C Rungs) 90° Bends

PRODUCT CODE	HEIGHT	WIDTH	THICKNESS ± % 10	WEIGHT (KG/PCS)
CC7 100 LB H	70	100	1,5	1,339
CC7 200 LB H	70	200	1,5	1,779
CC7 300 LB H	70	300	1,5	2,221
CC7 400 LB H	70	400	2,00	3,209
CC7 500 LB H	70	500	2,00	3,711
CC7 600 LB H	70	600	2,00	4,213

(H70/100/125/150 P.G / H.D.G.)

Welded Cable Ladder (C Rungs) Tee Bends

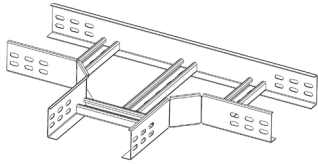

With a width up to 1000 mm / height up to 200 mm.

It is possible to carry a lot of amount of cable with a width of up to 1000 mm.

Ergonomic operation in every assembly area with its suitable design for all cable carrying systems.

www.traycanal.com
export@traycanal.com
+90 534 598 08 65

www.traycanal.com / Welded Cable Ladder / H70 HDG Welded Cable Ladder (C Rungs) Tee Bends

PRODUCT CODE	HEIGHT	WIDTH	THICKNESS ± % 10	WEIGHT (KG/PCS)
CC7 100 TB H	70	100	1,5	1,746
CC7 200 TB H	70	200	1,5	2,114
CC7 300 TB H	70	300	1,5	2,482
CC7 400 TB H	70	400	2,00	3,458
CC7 500 TB H	70	500	2,00	4,292
CC7 600 TB H	70	600	2,00	4,783

(H70/100/125/150 P.G / H.D.G.)

Welded Cable Ladder (C Rungs) 45° Bends

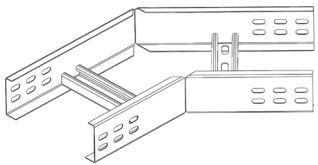

With a width up to 1000 mm / height up to 200 mm.

It is possible to carry a lot of amount of cable with a width of up to 1000 mm.

Ergonomic operation in every assembly area with its suitable design for all cable carrying systems.

www.traycanal.com
export@traycanal.com
+90 534 598 08 65

www.traycanal.com / Welded Cable Ladder / H70 HDG Welded Cable Ladder (C Rungs) 45° Bends

PRODUCT CODE	HEIGHT	WIDTH	THICKNESS ± % 10	WEIGHT (KG/PCS)
CC7 100 4B H	70	100	1,5	1,331
CC7 200 4B H	70	200	1,5	1,764
CC7 300 4B H	70	300	1,5	2,198
CC7 400 4B H	70	400	2,00	3,178
CC7 500 4B H	70	500	2,00	3,672
CC7 600 4B H	70	600	2,00	4,166

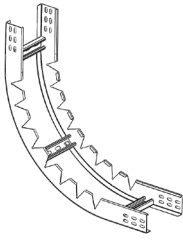

(H70/100/125/150 P.G / H.D.G.) Inside / Outside 90° Bends (Adjustable)

With a width up to 1000 mm / height up to 200 mm.

It is possible to carry a lot of amount of cable with a width of up to 1000 mm.

Ergonomic operation in every assembly area with its suitable design for all cable carrying systems.

www.traycanal.com
export@traycanal.com
+90 534 598 08 65

www.traycanal.com / Welded Cable Ladder / Inside / Outside 90° Bends (Adjustable)

PRODUCT CODE	HEIGHT	WIDTH	THICKNESS ± % 10	WEIGHT (KG/PCS)
CC7 100 IO H	70	100	1,5	2,087
CC7 200 IO H	70	200	1,5	2,373
CC7 300 IO H	70	300	1,5	2,658
CC7 400 IO H	70	400	2,00	3,592
CC7 500 IO H	70	500	2,00	3,878
CC7 600 IO H	70	600	2,00	4,163

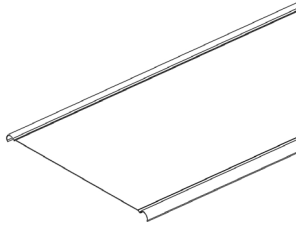

(PG / HDG) Snap-On Heavy Duty Cable Tray Covers

With a width up to 400 mm

This product is used to protect the cables from external factors and to close the cable trays.

There is no need to use a cover clamp, bolt etc. for this product.

Click System design provides fast assembly. It is enough to press and lock after put on the Cable Tray.

www.traycanal.com
export@traycanal.com
 +90 534 598 08 65

www.traycanal.com / Covers/ HDG Snap-On Heavy Duty Cable Tray Covers

PRODUCT CODE	HEIGHT	WIDTH	THICKNESS ± % 10	WEIGHT (KG/MT)
SO1 050 6CO P	10	50	0,6	0,275
SO1 100 7CO P	10	100	0,7	0,565
SO1 150 7CO P	10	150	0,7	0,801
SO1 200 7CO P	10	200	0,7	1,036
SO1 300 8CO P	10	300	0,8	1,758
SO1 400 9CO P	10	400	0,9	2,638

(PG / HDG) Heavy Duty Cable Trays & Cable Ladder

With a width up to 600 mm

This product is used to protect the cables from external factors and to close the cable trays.

It is possible to carry a lot of amount of cable with a width of up to 1000 mm.

Ergonomic operation in every assembly area with its suitable design for all cable carrying systems.

www.traycanal.com
export@traycanal.com
 +90 534 598 08 65

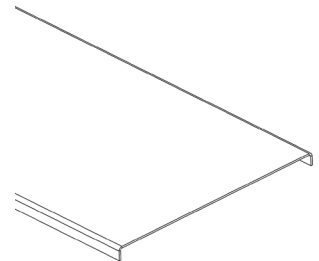

www.traycanal.com / Covers / HDG Heavy Duty Cable Tray Covers

PRODUCT CODE	HEIGHT	WIDTH	THICKNESS ± % 10	WEIGHT (KG/MT)
HD1 050 8CO P	10	50	0,8	0,385
HD1 100 8CO P	10	100	0,8	0,659
HD1 160 8CO P	10	160	0,8	0,989
HD1 200 1CO P	10	200	1,0	1,554
HD1 220 1CO P	10	220	1,0	1,696
HD1 260 1CO P	10	260	1,0	1,978
HD1 300 2CO P	10	300	1,2	2,763
HD1 400 2CO P	10	400	1,2	3,627
HD1 460 5CO P	10	460	1,5	5,275
HD1 500 5CO P	10	500	1,5	5,715
HD1 600 5CO P	10	600	1,5	6,814

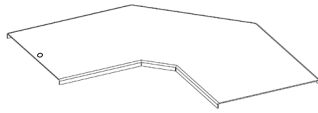

(PG / HDG) Cable Ladder 90° Bend Covers

Cable Ladders

This product is used to protect the cables from external factors and to close the cable trays.

Ergonomic operation in every assembly area with its suitable design for all cable carrying systems.

www.traycanal.com
export@traycanal.com
+90 534 598 08 65

www.traycanal.com / Covers/ PG Cable Ladder 90° Bend Covers

PRODUCT CODE	HEIGHT	WIDTH	THICKNESS ± % 10	WEIGHT (KG/PCS)
CLCO 100 LB P	10	100	1,2	0,453
CLCO 200 LB P	10	200	1,2	0,945
CLCO 300 LB P	10	300	1,2	1,616
CLCO 400 LB P	10	400	1,2	2,466
CLCO 500 LB P	10	500	1,2	3,495

(PG / HDG) Cable Ladder 45° Bend Covers

Cable Ladders

This product is used to protect the cables from external factors and to close the cable trays.

Ergonomic operation in every assembly area with its suitable design for all cable carrying systems.

www.traycanal.com
export@traycanal.com
+90 534 598 08 65

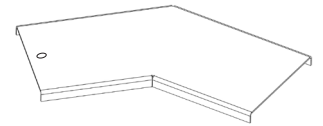

www.traycanal.com / Covers / PG Cable Ladder 45° Bend Covers

PRODUCT CODE	HEIGHT	WIDTH	THICKNESS ± % 10	WEIGHT (KG/PCS)
CLCO 100 4B P	10	100	1,2	0,429
CLCO 200 4B P	10	200	1,2	0,895
CLCO 300 4B P	10	300	1,2	1,531
CLCO 400 4B P	10	400	1,2	2,337
CLCO 500 4B P	10	500	1,2	3,312
CLCO 600 4B P	10	600	1,2	4,456

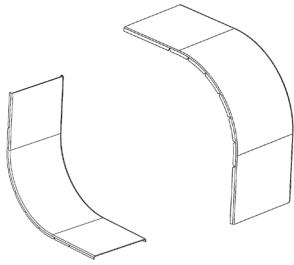

(PG / HDG) 90° Inside / Outside Vertical Bend Cover (Adjustable)

Cable Trays , Cable Ladders

This product is used to protect the cables from external factors and to close the cable trays.

Ergonomic operation in every assembly area with its suitable design for all cable carrying systems.

www.traycanal.com
export@traycanal.com
+90 534 598 08 65

www.traycanal.com / Covers / HDG 90° Inside / Outside Vertical Bend Covers (Adjustable)

PRODUCT CODE	HEIGHT	WIDTH	THICKNESS ± % 10	WEIGHT (KG/PCS)
CLCO 050 IV P	10	50	1,2	0,568
CLCO 100 IV P	10	100	1,2	1,074
CLCO 160 IV P	10	160	1,2	1,554
CLCO 200 IV P	10	200	1,2	1,969
CLCO 220 IV P	10	220	1,2	2,111
CLCO 250 IV P	10	250	1,2	2,325
CLCO 300 IV P	10	300	1,2	2,864
CLCO 400 IV P	10	400	1,2	3,759
CLCO 450 IV P	10	450	1,2	4,365
CLCO 500 IV P	10	500	1,2	4,653
CLCO 600 IV P	10	600	1,2	5,548

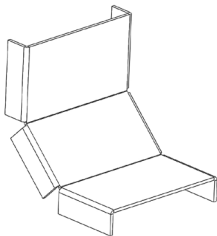

(PG / HDG) H40-150 90° Inside Vertical Bend Cover (Fixed)

Cable Trays , Cable Ladders

This product is used to protect the cables from external factors and to close the cable trays.

Ergonomic operation in every assembly area with its suitable design for all cable carrying systems.

www.traycanal.com
export@traycanal.com
+90 534 598 08 65

www.traycanal.com / Covers / H50 HDG 90° Inside Vertical Bend Covers (Fixed)

PRODUCT CODE	HEIGHT	WIDTH	THICKNESS ± % 10	WEIGHT (KG/PCS)
CLCO5 050 IV P	10	50	1,0	0,339
CLCO5 100 IV P	10	100	1,0	0,582
CLCO5 160 IV P	10	160	1,0	0,873
CLCO5 200 IV P	10	200	1,0	1,066
CLCO5 220 IV P	10	220	1,2	1,163
CLCO5 260 IV P	10	260	1,2	1,357
CLCO5 300 IV P	10	300	1,2	1,551
CLCO5 400 IV P	10	400	1,2	2,036
CLCO5 460 IV P	10	460	1,2	2,327
CLCO5 500 IV P	10	500	1,2	2,521
CLCO5 600 IV P	10	600	1,2	3,005

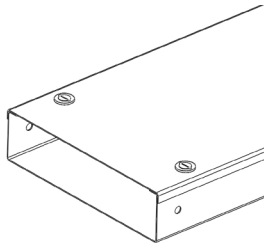

(PG/HDG) H50 Trunking Cable Trays

With a width up to 200 mm / height up to 200 mm

It is possible to carry a lot of amount of cable with a width of up to 200 mm.

Trunking Cable Trays can be installed quickly. It provides economic and easy working opportunities.

This product is designed for cable tray carrying system. It can be used for different purposes

www.traycanal.com
export@traycanal.com
+90 534 598 08 65

www.traycanal.com / Trunking Cable Trays / H50 Trunking Cable Trays

PRODUCT CODE	HEIGHT	WIDTH	THICKNESS ± % 10	WEIGHT (KG/MT)
TC5 050 1CT P	50	50	1,0	1,837
TC5 075 1CT P	50	75	1,0	2,229
TC5 100 1CT P	50	100	1,0	2,622
TC5 150 1CT P	50	150	1,0	3,407
TC5 200 1CT P	50	200	1,0	4,192
TC5 050 1CT H	50	50	1,0	1,837
TC5 075 1CT H	50	75	1,0	2,229
TC5 100 1CT H	50	100	1,0	2,622
TC5 150 1CT H	50	150	1,0	3,407
TC5 200 1CT H	50	200	1,0	4,192

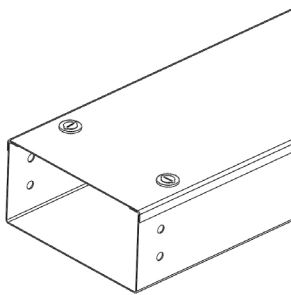

(PG/HDG) H75 Trunking Cable Trays

With a width up to 200 mm / height up to 200 mm

It is possible to carry a lot of amount of cable with a width of up to 200 mm.

Trunking Cable Trays can be installed quickly. It provides economic and easy working opportunities.

This product is designed for cable tray carrying system. It can be used for different purposes

www.traycanal.com
export@traycanal.com
+90 534 598 08 65

www.traycanal.com / Trunking Cable Trays / H75 Trunking Cable Trays

PRODUCT CODE	HEIGHT	WIDTH	THICKNESS ± % 10	WEIGHT (KG/MT)
TC7 075 1CT P	75	75	1,0	2,622
TC7 100 1CT P	75	100	1,0	3,014
TC7 150 1CT P	75	150	1,0	3,799
TC7 200 1CT P	75	200	1,0	4,584
TC7 075 1CT H	75	50	1,0	2,229
TC7 100 1CT H	75	100	1,0	3,014
TC7 150 1CT H	75	150	1,0	3,799
TC7 200 1CT H	75	200	1,0	4,584

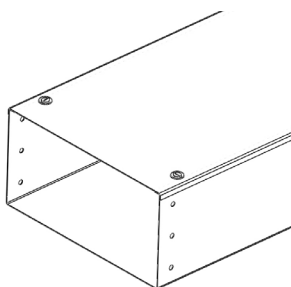

(PG/HDG) H100 Trunking Cable

With a width up to 200 mm / height up to 200 mm

It is possible to carry a lot of amount of cable with a width of up to 200 mm.

Trunking Cable Trays can be installed quickly. It provides economic and easy working opportunities.

This product is designed for cable tray carrying system. It can be used for different purposes

www.traycanal.com
export@traycanal.com
+90 534 598 08 65

www.traycanal.com / Trunking Cable Trays / H100 Trunking Cable Trays

PRODUCT CODE	HEIGHT	WIDTH	THICKNESS ± % 10	WEIGHT (KG/MT)
TC1 100 1CT P	100	100	1,0	3,407
TC1 150 1CT P	100	150	1,0	4,192
TC1 200 1CT P	100	200	1,0	4,977
TC1 100 1CT H	100	100	1,0	3,407
TC1 150 1CT H	100	150	1,0	4,192
TC1 200 1CT H	100	200	1,0	4,977

(PG/HDG) H150 Trunking Cable Trays

With a width up to 200 mm / height up to 200 mm

It is possible to carry a lot of amount of cable with a width of up to 200 mm.

Trunking Cable Trays can be installed quickly. It provides economic and easy working opportunities.

This product is designed for cable tray carrying system. It can be used for different purposes

www.traycanal.com
export@traycanal.com
+90 534 598 08 65

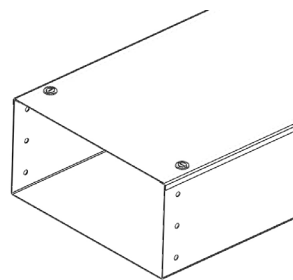

www.traycanal.com / Trunking Cable Trays / H150 Trunking Cable Trays

PRODUCT CODE	HEIGHT	WIDTH	THICKNESS ± % 10	WEIGHT (KG/MT)
TC2 150 1CT P	150	150	1,0	4,977
TC2 200 1CT P	150	200	1,0	5,762
TC2 150 1CT H	150	150	1,0	4,977
TC2 200 1CT H	150	200	1,0	0,000

(PG/HDG) H200 Trunking Cable

With a width up to 200 mm / height up to 200 mm

It is possible to carry a lot of amount of cable with a width of up to 200 mm.

Trunking Cable Trays can be installed quickly. It provides economic and easy working opportunities.

This product is designed for cable tray carrying system. It can be used for different purposes

www.traycanal.com
export@traycanal.com
+90 534 598 08 65

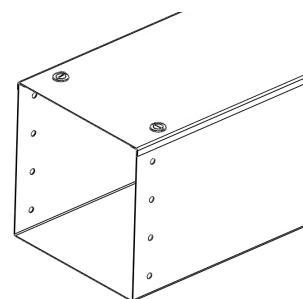

www.traycanal.com / Trunking Cable Trays / H150 Trunking Cable Trays

PRODUCT CODE	HEIGHT	WIDTH	THICKNESS ± % 10	WEIGHT (KG/MT)
TC3 200 1CT P	200	200	1,0	6,547
TC3 200 1CT H	200	200	1,0	6,547

(PG/HDG) Trunking Cable Tray Connection Cou-

With a width up to 200 mm / height up to 200 mm

It is possible to carry a lot of amount of cable with a width of up to 200 mm.

Trunking Cable Trays can be installed quickly. It provides economic and easy working opportunities.

This product is designed for cable tray carrying system. It can be used for different purposes

www.traycanal.com
export@traycanal.com
+90 534 598 08 65

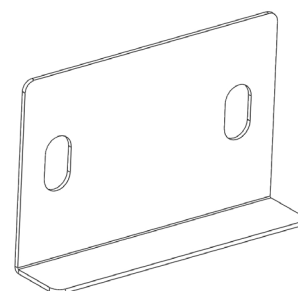

www.traycanal.com / Trunking Cable Trays / Trunking Cable Tray Connection Couplers

PRODUCT CODE	HEIGHT	WIDTH	THICKNESS ± % 10	WEIGHT (KG/PCS)
TCC5 070 10 P	50	70	1,0	0,032
TCC7 070 10 P	75	70	1,0	0,045
TCC1 070 10 P	100	70	1,0	0,058
TCC2 070 10 P	150	70	1,0	0,084
TCC3 070 10 P	200	70	1,0	0,111
TCC5 070 10 H	50	70	1,0	0,035
TCC7 070 10 H	75	70	1,0	0,049
TCC1 070 10 H	100	70	1,0	0,063
TCC2 070 10 H	150	70	1,0	0,092
TCC3 070 10 H	200	70	1,0	0,121

(PG/HDG) H50-200 Trunking Cable Tray

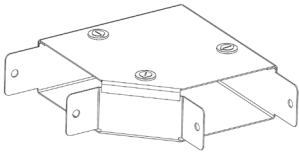

With a width up to 200 mm / height up to 200 mm

It is possible to carry a lot of amount of cable with a width of up to 200 mm.

Trunking Cable Trays can be installed quickly. It provides economic and easy working opportunities.

This product is designed for cable tray carrying system. It can be used for different purposes

www.traycanal.com
export@traycanal.com
+90 534 598 08 65

www.traycanal.com / Trunking Cable Trays / H50 Trunking Cable Tray 90° Bends

PRODUCT CODE	HEIGHT	WIDTH	THICKNESS ± % 10	WEIGHT (KG/PCS)
TC5 050 LB P	50	50	1,0	0,354
TC5 075 LB P	50	75	1,0	0,478
TC5 100 LB P	50	100	1,0	0,619
TC5 150 LB P	50	150	1,0	0,957
TC5 200 LB P	50	200	1,0	1,295
TC5 050 LB H	50	50	1,0	0,354
TC5 075 LB H	50	75	1,0	0,478
TC5 100 LB H	50	100	1,0	0,619
TC5 150 LB H	50	150	1,0	0,957
TC5 200 LB H	50	200	1,0	1,295

(PG/HDG) H50-200 Trunking Cable Tray Tee

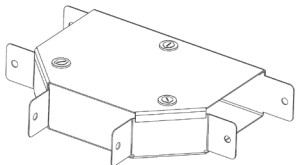

With a width up to 200 mm / height up to 200 mm

It is possible to carry a lot of amount of cable with a width of up to 200 mm.

Trunking Cable Trays can be installed quickly. It provides economic and easy working opportunities.

This product is designed for cable tray carrying system. It can be used for different purposes

www.traycanal.com
export@traycanal.com
+90 534 598 08 65

www.traycanal.com / Trunking Cable Trays / H50 Trunking Cable Tray Tee Bends

PRODUCT CODE	HEIGHT	WIDTH	THICKNESS ± % 10	WEIGHT (KG/PCS)
TC5 050 TB P	50	50	1,0	0,458
TC5 075 TB P	50	75	1,0	0,588
TC5 100 TB P	50	100	1,0	0,733
TC5 150 TB P	50	150	1,0	1,092
TC5 200 TB P	50	200	1,0	1,404
TC5 050 TB H	50	50	1,0	0,458
TC5 075 TB H	50	75	1,0	0,588
TC5 100 TB H	50	100	1,0	0,733
TC5 150 TB H	50	150	1,0	1,092
TC5 200 TB H	50	200	1,0	1,404

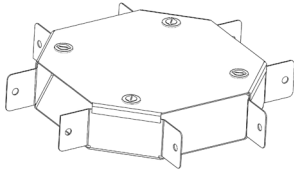

(PG/HDG) H50 Trunking Cable Tray Four Way

With a width up to 200 mm / height up to 200 mm

It is possible to carry a lot of amount of cable with a width of up to 200 mm.

Trunking Cable Trays can be installed quickly. It provides economic and easy working opportunities.

This product is designed for cable tray carrying system. It can be used for different purposes

www.traycanal.com
export@traycanal.com
+90 534 598 08 65

www.traycanal.com / Trunking Cable Trays / H50 Trunking Cable Tray Four Way Bends

PRODUCT CODE	HEIGHT	WIDTH	THICKNESS ± % 10	WEIGHT (KG/PCS)
TC5 050 FB P	50	50	1,0	0,863
TC5 075 FB P	50	75	1,0	0,572
TC5 100 FB P	50	100	1,0	0,707
TC5 150 FB P	50	150	1,0	1,232
TC5 200 FB H	50	200	1,0	1,602
TC5 050 FB H	50	50	1,0	0,863
TC5 075 FB H	50	75	1,0	0,572
TC5 100 FB H	50	100	1,0	0,707
TC5 150 FB H	50	150	1,0	1,232
TC5 200 FB H	50	200	1,0	1,602

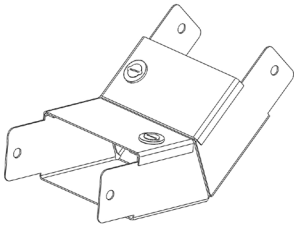

(PG/HDG) H50-200 Trunking Cable Tray Vertical

With a width up to 200 mm / height up to 200 mm

It is possible to carry a lot of amount of cable with a width of up to 200 mm.

Trunking Cable Trays can be installed quickly. It provides economic and easy working opportunities.

This product is designed for cable tray carrying system. It can be used for different purposes

www.traycanal.com
export@traycanal.com
+90 534 598 08 65

www.traycanal.com / Trunking Cable Trays / H50 Trunking Cable Tray Vertical 45° Bends

PRODUCT CODE	HEIGHT	WIDTH	THICKNESS ± % 10	WEIGHT (KG/PCS)
TC5 050 4V P	50	50	1,0	0,286
TC5 075 4V P	50	75	1,0	0,328
TC5 100 4V P	50	100	1,0	0,374
TC5 150 4V P	50	150	1,0	0,468
TC5 200 4V P	50	200	1,0	0,562
TC5 050 4V H	50	50	1,0	0,286
TC5 075 4V H	50	75	1,0	0,328
TC5 100 4V H	50	100	1,0	0,374
TC5 150 4V H	50	150	1,0	0,468
TC5 200 4V H	50	200	1,0	0,562

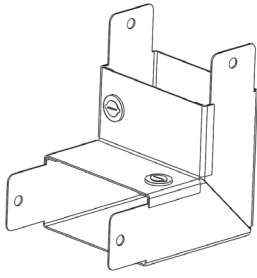

(PG/HDG) H50-200 Trunking Cable Tray Vertical 90° Bends

With a width up to 200 mm / height up to 200 mm

It is possible to carry a lot of amount of cable with a width of up to 200 mm.

Trunking Cable Trays can be installed quickly. It provides economic and easy working opportunities.

This product is designed for cable tray carrying system. It can be used for different purposes

www.traycanal.com
export@traycanal.com
+90 534 598 08 65

www.traycanal.com / Trunking Cable Trays / H50 Trunking Cable Tray Vertical 90° Bends

PRODUCT CODE	HEIGHT	WIDTH	THICKNESS ± % 10	WEIGHT (KG/PCS)
TC5 050 9V P	50	50	1,0	0,286
TC5 075 9V P	50	75	1,0	0,328
TC5 100 9V P	50	100	1,0	0,374
TC5 150 9V P	50	150	1,0	0,468
TC5 200 9V P	50	200	1,0	0,562
TC5 050 9V H	50	50	1,0	0,286
TC5 075 9V H	50	75	1,0	0,328
TC5 100 9V H	50	100	1,0	0,374
TC5 150 9V H	50	150	1,0	0,468
TC5 200 9V H	50	200	1,0	0,562

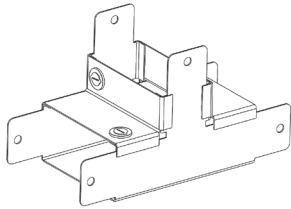

(PG/HDG) H50 Trunking Cable Tray Vertical Tee Bends

With a width up to 200 mm / height up to 200 mm

It is possible to carry a lot of amount of cable with a width of up to 200 mm.

Trunking Cable Trays can be installed quickly. It provides economic and easy working opportunities.

This product is designed for cable tray carrying system. It can be used for different purposes

www.traycanal.com
export@traycanal.com
+90 534 598 08 65

www.traycanal.com / Trunking Cable Trays / H50 Trunking Cable Tray Vertical Tee Bends

PRODUCT CODE	HEIGHT	WIDTH	THICKNESS ± % 10	WEIGHT (KG/PCS)
TC5 050 VT P	50	50	1,0	0,374
TC5 075 VT P	50	75	1,0	0,447
TC5 100 VT P	50	100	1,0	0,499
TC5 150 VT P	50	150	1,0	0,619
TC5 200 VT P	50	200	1,0	0,738
TC5 050 VT H	50	50	1,0	0,374
TC5 075 VT H	50	75	1,0	0,447
TC5 100 VT H	50	100	1,0	0,499
TC5 150 VT H	50	150	1,0	0,619
TC5 200 VT H	50	200	1,0	0,738

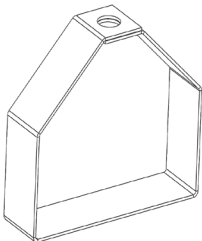

(PG / HDG) Trunking Cable Tray Carriers

With a width up to 200 mm / height up to 200 mm

It is possible to carry a lot of amount of cable with a width of up to 200 mm.

Trunking Cable Trays can be installed quickly. It provides economic and easy working opportunities.

This product is designed for cable tray carrying system. It can be used for different purposes

www.traycanal.com
export@traycanal.com
+90 534 598 08 65

www.traycanal.com / Trunking Cable Trays / Trunking Cable Tray Carriers

PRODUCT CODE	HEIGHT	WIDTH	THICKNESS ± % 10	WEIGHT (KG/PCS)
TC5 050 CR1 P	55	55	1,0	0,087
TC5 075 CR1 P	85	85	1,0	0,117
TC5 100 CR1 P	105	105	1,0	0,158
TC5 150 CR1 P	155	155	1,0	0,168
TC5 200 CR1 P	205	205	1,0	0,194
TC5 050 CR1 H	55	55	1,0	0,095
TC5 075 CR1 H	85	85	1,0	0,128
TC5 100 CR1 H	105	105	1,0	0,172
TC5 150 CR1 H	155	155	1,0	0,183
TC5 200 CR1 H	205	205	1,0	0,212

(PG / HDG) Trunking Cable Tray Carriers

With a width up to 200 mm / height up to 200 mm

It is possible to carry a lot of amount of cable with a width of up to 200 mm.

Trunking Cable Trays can be installed quickly. It provides economic and easy working opportunities.

This product is designed for cable tray carrying system. It can be used for different purposes

www.traycanal.com
export@traycanal.com
+90 534 598 08 65

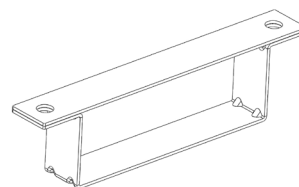

www.traycanal.com / Trunking Cable Trays / PG Trunking Cable Tray Carrier

PRODUCT CODE	HEIGHT	WIDTH	THICKNESS ± % 10	WEIGHT (KG/PCS)
TC5 050 CR2 P	55	50	1,0	0,153
TC5 075 CR2 P	55	75	1,0	0,178
TC5 100 CR2 P	55	100	1,0	0,204
TC5 150 CR2 P	55	150	1,0	0,250
TC5 200 CR2 P	55	200	1,0	0,290
TC7 075 CR2 P	80	75	1,0	0,204
TC7 100 CR2 P	80	100	1,0	0,229
TC7 150 CR2 P	80	150	1,0	0,275
TC7 200 CR2 P	80	200	1,0	0,326
TC1 100 CR2 P	105	100	1,0	0,250
TC1 150 CR2 P	105	150	1,0	0,301
TC1 200 CR2 P	105	200	1,0	0,454
TC2 150 CR2 P	155	150	1,0	0,448
TC2 200 CR2 P	155	200	1,0	0,408
TC3 200 CR2 P	205	200	1,0	0,459

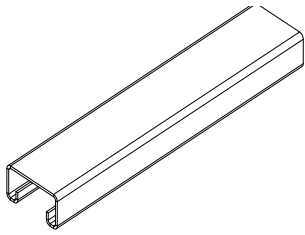

(PG/HDG) 41x21 C Profiles

Cable Trays , Cable Ladders , Wiremesh Cable Trays , Trunking Cable Trays

C Profiles can be used in many areas as well as in cable trays assembly.

C Profile can be used in different sectors and in different sizes. Therefore, holes can be added to the profiles to facilitate use. There are options without holes, one side with holes and three sides with holes. www.traycanal.com
export@traycanal.com
 +90 534 598 08 65

www.traycanal.com / C Profile / 41x21 C Profiles (No Holes)

PRODUCT CODE	HEIGHT	WIDTH	LENGTH	THICKNESS ± %10	WEIGHT (KG/MT)
C0 21 5R P	21	41	3000	1,5	1,066
C0 21 0R P	21	41	3000	2,0	1,447
C0 21 4R P	21	41	3000	2,5	1,827
C0 21 5R H	21	41	3000	1,5	1,119
C0 21 0R H	21	41	3000	2,0	1,519
C0 21 4R H	21	41	3000	2,5	1,919

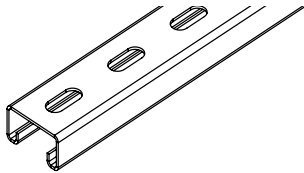

(PG/HDG) 41x21 C Profiles

Cable Trays , Cable Ladders , Wiremesh Cable Trays , Trunking Cable Trays

C Profiles can be used in many areas as well as in cable trays assembly.

C Profile can be used in different sectors and in different sizes. Therefore, holes can be added to the profiles to facilitate use. There are options without holes, one side with holes and three sides with holes. www.traycanal.com
export@traycanal.com
 +90 534 598 08 65

www.traycanal.com / C Profile / 41x21 C Profiles (One Holes)

PRODUCT CODE	HEIGHT	WIDTH	LENGTH	THICKNESS ± %10	WEIGHT (KG/MT)
C1 21 5R P	21	41	3000	1,5	1,034
C1 21 0R P	21	41	3000	2,0	1,403
C1 21 4R P	21	41	3000	2,5	1,773
C1 21 5R H	21	41	3000	1,5	1,096
C1 21 0R H	21	41	3000	2,0	1,488
C1 21 4R H	21	41	3000	2,5	1,879

(PG/HDG) 41x41 C Profiles

Cable Trays , Cable Ladders , Wiremesh Cable Trays , Trunking Cable Trays

C Profiles can be used in many areas as well as in cable trays assembly.

C Profile can be used in different sectors and in different sizes. Therefore, holes can be added to the profiles to facilitate use. There are options without holes, one side with holes and three sides with holes.

www.traycanal.com
export@traycanal.com
+90 534 598 08 65

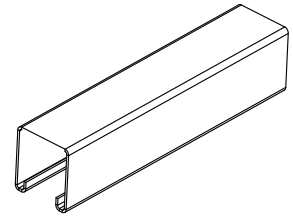

www.traycanal.com / C Profile / 41x41 C Profiles (No Holes)

PRODUCT CODE	HEIGHT	WIDTH	LENGTH	THICKNESS ± %10	WEIGHT (KG/MT)
C0 41 5R P	41	41	3000	1,5	1,506
C0 41 0R P	41	41	3000	2,0	2,043
C0 41 4R P	41	41	3000	2,5	2,581
C0 41 5R H	41	41	3000	1,5	1,581
C0 41 0RH	41	41	3000	2,0	2,146

(PG/HDG) 41x41 C Profiles

Cable Trays , Cable Ladders , Wiremesh Cable Trays , Trunking Cable Trays

C Profiles can be used in many areas as well as in cable trays assembly.

C Profile can be used in different sectors and in different sizes. Therefore, holes can be added to the profiles to facilitate use. There are options without holes, one side with holes and three sides with holes.

www.traycanal.com
export@traycanal.com
+90 534 598 08 65

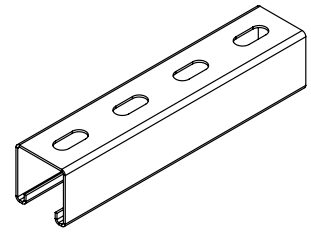

www.traycanal.com / C Profile / 41x41 C Profiles (One Holes)

PRODUCT CODE	HEIGHT	WIDTH	LENGTH	THICKNESS ± %10	WEIGHT (KG/MT)
C1 41 5R P	41	41	3000	1,5	1,460
C1 41 0R P	41	41	3000	2,0	1,982
C1 41 4R P	41	41	3000	2,5	2,504
C1 41 5R H	41	41	3000	1,5	1,548
C1 41 0R H	41	41	3000	2,0	2,101

(PG/HDG) 41x41 C Profiles

Cable Trays , Cable Ladders , Wiremesh Cable Trays , Trunking Cable Trays

C Profiles can be used in many areas as well as in cable trays assembly.

C Profile can be used in different sectors and in different sizes. Therefore, holes can be added to the profiles to facilitate use. There are options without holes, one side with holes and three sides with holes.

www.traycanal.com
export@traycanal.com
+90 534 598 08 65

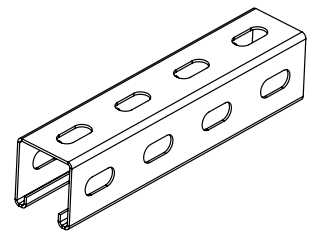

www.traycanal.com / C Profile / 41x41 C Profiles (Three Holes)

PRODUCT CODE	HEIGHT	WIDTH	LENGTH	THICKNESS ± %10	WEIGHT (KG/MT)
C3 41 5R P	41	41	3000	1,5	1,415
C3 41 0R P	41	41	3000	2,0	1,921
C3 41 4R P	41	41	3000	2,5	2,426
C3 41 5R H	41	41	3000	1,5	1,468
C3 41 0R H	41	41	3000	2,0	1,993

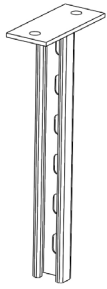

(HDG) 41x21 / 41x41 C Profile Support Systems

Cable Trays , Cable Ladders , Wiremesh Cable Trays , Trunking Cable Trays

C Profiles can be used in many areas as well as in cable trays assembly.

C Profile can be used in different sectors and in different sizes. Therefore, holes can be added to the profiles to facilitate use. There are options without holes, one side with holes and three sides with holes.

www.traycanal.com
export@traycanal.com
+90 534 598 08 65

www.traycanal.com / C Profile / 41x21 C Hanging Support Systems

PRODUCT CODE	HEIGHT	WIDTH	LENGTH	THICKNESS ± %10	WEIGHT(KG/PCS)
C21 050 0S H	21	41	500	2	0,960
C21 100 0S H	21	41	1000	2	1,646
C21 150 0S H	21	41	1500	2	2,331
C21 200 0S H	21	41	2000	2	3,016
C21 250 0S H	21	41	2500	2	3,702
C21 300 0S H	21	41	3000	2	4,387
C21 050 4S H	21	41	500	2,5	1,151
C21 100 4S H	21	41	1000	2,5	2,026
C21 150 4S H	21	41	1500	2,5	2,902
C21 200 4S H	21	41	2000	2,5	3,778
C21 250 4S H	21	41	2500	2,5	4,653
C21 300 4S H	21	41	3000	2,5	5,529

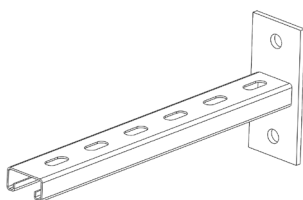

(HDG / PG) 41x21 / 41x41 C Profile Brackets

Cable Trays , Cable Ladders , Wiremesh Cable Trays , Trunking Cable Trays

C Profiles can be used in many areas as well as in cable trays assembly.

C Profile can be used in different sectors and in different sizes. Therefore, holes can be added to the profiles to facilitate use. There are options without holes, one side with holes and three sides with holes.

www.traycanal.com
export@traycanal.com
+90 534 598 08 65

www.traycanal.com / C Profile / 41x21 C Profile Brackets

PRODUCT CODE	HEIGHT	WIDTH	LENGTH	THICKNESS ± %10	WEIGHT(KG/PCS)
C21 100 5PB H	21	41	100	1,5	0,385
C21 200 5PB H	21	41	200	1,5	0,490
C21 300 5PB H	21	41	300	1,5	0,595
C21 400 5PB H	21	41	400	1,5	0,700
C21 500 5PB H	21	41	500	1,5	0,805
C21 600 5PB H	21	41	600	1,5	0,910
C21 100 0PB H	21	41	100	2,0	0,424
C21 200 0PB H	21	41	200	2,0	0,568
C21 300 0PB H	21	41	300	2,0	0,712
C21 400 0PB H	21	41	400	2,0	0,855
C21 500 0PB H	21	41	500	2,0	0,999
C21 600 0PB H	21	41	600	2,0	1,143

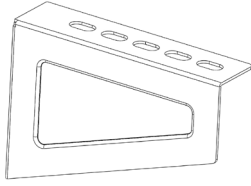

(PG/HDG) Support For Wall Mounting

Cable Trays , Cable Ladders , Wiremesh Cable Trays , Trunking Cable Trays

This product is designed for cable tray carrying system. It can be used for different purposes

This product is used by fixing it to the Cable Tray with M8x15 Bolt / Nut.

Ergonomic operation in every assembly area with its suitable design for all cable carrying systems.

www.traycanal.com
export@traycanal.com
+90 534 598 08 65

www.traycanal.com / Support Systems / Support For Wall Mounting

PRODUCT CODE	HEIGHT	WIDTH	LENGTH	THICKNESS ± %10	WEIGHT(KG/PCS)
SW1 050 P	90	32	60	1,5	0,077
SW1 100 P	90	32	110	1,5	0,122
SW1 160 P	90	32	170	1,5	0,173
SW1 200 P	90	32	210	1,5	0,345
SW1 300 P	90	32	310	1,5	0,682
SW1 400 P	90	32	410	2,0	1,111
SW1 500 P	90	32	510	2,0	1,346
SW1 660 P	90	32	610	2,0	1,581
SW1 050 H	90	32	60	1,5	0,085
SW1 100 H	90	32	110	1,5	0,134
SW1 160 H	90	32	170	1,5	0,191
SW1 200 H	90	32	210	1,5	0,381
SW1 300 H	90	32	310	1,5	0,753
SW1 400 H	90	32	410	2,0	1,228
SW1 500 H	90	32	510	2,0	1,488
SW1 660 H	90	32	610	2,0	1,747

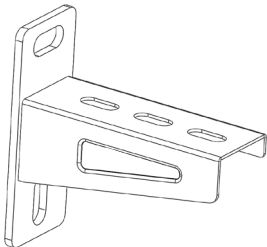

(EG/HDG) Support For Wall Mounting

Cable Trays , Cable Ladders , Wiremesh Cable Trays , Trunking Cable Trays

This product is designed for cable tray carrying system. It can be used for different purposes

This product is used by fixing it to the Cable Tray with M8x15 Bolt / Nut.

Ergonomic operation in every assembly area with its suitable design for all cable carrying systems.

www.traycanal.com
export@traycanal.com
+90 534 598 08 65

www.traycanal.com / Support Systems / Support For Wall Mounting (Welded)

PRODUCT CODE	HEIGHT	WIDTH	LENGTH	THICKNESS ± %10	WEIGHT(KG/PCS)
SW2 100 E	75	45	100	1,5	0,000
SW2 200 E	75	45	200	1,5	0,000
SW2 300 E	75	45	300	1,5	0,000
SW2 400 E	110	45	400	2,0	0,000
SW2 500 E	110	45	500	2,0	0,000
SW2 660 E	110	45	600	2,0	0,000
SW2 100 H	75	45	100	1,5	0,226
SW2 200 H	75	45	200	1,5	0,336
SW2 300 H	75	45	300	1,5	0,615
SW2 400 H	110	45	400	2,0	0,820
SW2 500 H	110	45	500	2,0	0,971
SW2 660 H	110	45	600	2,0	1,123

(HDG) Wall and Floor Fixing Units

Cable Trays , Cable Ladders , Wiremesh Cable Trays , Trunking Cable Trays

This product is designed for cable tray carrying system. It can be used for different purposes

This product is used by fixing it to the Cable Tray with M8x15 Bolt / Nut.

Ergonomic operation in every assembly area with its suitable design for all cable carrying systems.

www.traycanal.com
export@traycanal.com
+90 534 598 08 65

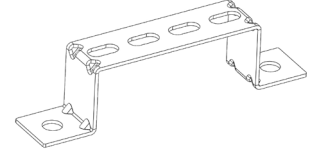

www.traycanal.com / Support Systems / Wall and Floor Fixing Units

PRODUCT CODE	HEIGHT	WIDTH	LENGTH	THICKNESS ± %10	WEIGHT(KG/PCS)
WF30 100 H	40	30	100	3,0	0,182
WF30 200 H	40	30	200	3,0	0,256
WF30 300 H	40	30	300	3,0	0,330
WF30 400 H	40	30	400	3,0	0,404
WF30 500 H	40	30	500	3,0	0,478
WF30 600 H	40	30	600	3,0	0,553

(PG/HDG) Bracket for Ceiling Mounting

Cable Trays , Cable Ladders , Wiremesh Cable Trays , Trunking Cable Trays

This product is designed for cable tray carrying system. It can be used for different purposes

This product is used by fixing it to the Cable Tray with M8x15 Bolt / Nut.

Ergonomic operation in every assembly area with its suitable design for all cable carrying systems.

www.traycanal.com
export@traycanal.com
+90 534 598 08 65

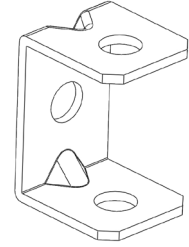

www.traycanal.com / Support Systems / Bracket for ceiling Mounting

PRODUCT CODE	HEIGHT	WIDTH	LENGTH	THICKNESS ± %10	WEIGHT(KG/PCS)
BCM 1 P	40	30	100	3,0	0,111
BCM 1 H	40	30	200	3,0	0,120

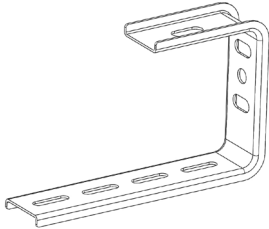

(PG / HDG) Cable Tray Carrier (C Type)

Cable Trays , Cable Ladders , Wiremesh Cable Trays , Trunking Cable Trays

Kablo Kanalı Taşıma için dizayn edilmiştir. Özel amaçlar içinde kullanılabilir.

This product is used by fixing it to the Cable Tray with M8x15 Bolt / Nut.

Ergonomic operation in every assembly area with its suitable design for all cable carrying systems.

www.traycanal.com
export@traycanal.com
+90 534 598 08 65

www.traycanal.com / Support Systems / Cable Tray Carrier

PRODUCT CODE	HEIGHT	WIDTH	LENGTH	THICKNESS ± %10	WEIGHT(KG/PCS)
SW3 050 P	125	43	60	2,0	0,281
SW3 100 P	125	43	110	2,0	0,300
SW3 160 P	125	43	160	2,0	0,355
SW3 200 P	125	43	210	2,0	0,392
SW3 260 P	125	43	270	2,0	0,448
SW3 300 P	125	43	310	2,0	0,485

(PG / HDG) Cable Tray Carrier (L Type)

Cable Trays , Cable Ladders , Wiremesh Cable Trays , Trunking Cable Trays

This product is designed for cable tray carrying system. It can be used for different purposes

This product is used by fixing it to the Cable Tray with M8x15 Bolt / Nut.

Ergonomic operation in every assembly area with its suitable design for all cable carrying systems.

www.traycanal.com
export@traycanal.com
+90 534 598 08 65

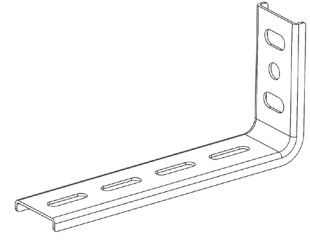

www.traycanal.com / Support Systems / Cable Tray Carrier

PRODUCT CODE	HEIGHT	WIDTH	LENGTH	THICKNESS ± %10	WEIGHT(KG/PCS)
SW4 050 P	125	43	60	2,0	0,138
SW4 100 P	125	43	110	2,0	0,185
SW4 160 P	125	43	160	2,0	0,240
SW4 200 P	125	43	210	2,0	0,277
SW4 260 P	125	43	270	2,0	0,332
SW4 300 P	125	43	310	2,0	0,369

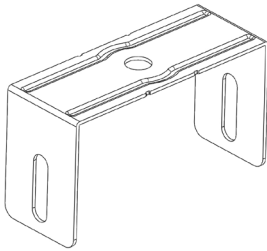

(PG/HDG) Y Type Tray Carriers

Cable Trays , Cable Ladders , Wiremesh Cable Trays , Trunking Cable Trays

This product is designed for cable tray carrying system. It can be used for different purposes

This product is used by fixing it to the Cable Tray with M8x15 Bolt / Nut.

Ergonomic operation in every assembly area with its suitable design for all cable carrying systems.

www.traycanal.com
export@traycanal.com
+90 534 598 08 65

www.traycanal.com / Support Systems / Y Type Tray Carriers

PRODUCT CODE	HEIGHT	WIDTH	LENGTH	THICKNESS ± %10	WEIGHT(KG/PCS)
BCM 050 P	58	40	50	1,2	0,066
BCM 100 P	58	40	100	1,2	0,085
BCM 200 P	58	40	200	1,2	0,123
BCM 050 H	58	40	50	1,2	0,070
BCM 100 H	58	40	100	1,2	0,091
BCM 200 H	58	40	200	1,2	0,131

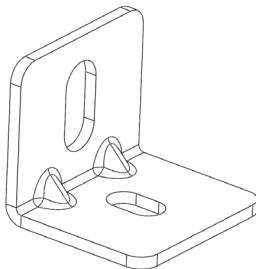

(PG/HDG) L Type Tray Carriers

Cable Trays , Cable Ladders , Wiremesh Cable Trays , Trunking Cable Trays

This product is designed for cable tray carrying system. It can be used for different purposes

This product is used by fixing it to the Cable Tray with M8x15 Bolt / Nut.

Ergonomic operation in every assembly area with its suitable design for all cable carrying systems.

www.traycanal.com
export@traycanal.com
+90 534 598 08 65

www.traycanal.com / Support Systems / L Type Tray Carrier

PRODUCT CODE	HEIGHT	WIDTH	LENGTH	THICKNESS ± %10	WEIGHT(KG/PCS)
BCM 3 P	40	45	40	3,0	0,085
BCM 3 H	40	45	40	3,0	0,091

(PG/HDG) U Type Tray Carriers

Cable Trays , Cable Ladders , Wiremesh Cable Trays , Trunking Cable Trays

This product is designed for cable tray carrying system. It can be used for different purposes

This product is used by fixing it to the Cable Tray with M8x15 Bolt / Nut.

Ergonomic operation in every assembly area with its suitable design for all cable carrying systems.

www.traycanal.com
export@traycanal.com
+90 534 598 08 65

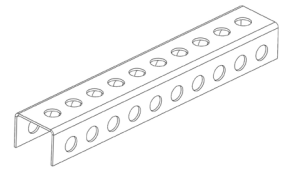

www.traycanal.com / Support Systems / PG U Type Tray Carriers

PRODUCT CODE	HEIGHT	WIDTH	LENGTH	THICKNESS ± %10	WEIGHT(KG/PCS)
U30152 P	25	35	150	1,2	0,100
U30155 P	25	35	150	1,5	0,135
U30172 P	25	35	170	1,2	0,120
U30175 P	25	35	170	1,5	0,155
U30212 P	25	35	210	1,2	0,150
U30215 P	25	35	210	1,5	0,190
U30222 P	25	35	220	1,2	0,155
U30225 P	25	35	220	1,5	0,200
U30252 P	25	35	250	1,2	0,175
U30255 P	25	35	250	1,5	0,225
U30352 P	25	35	350	1,2	0,250
U30355 P	25	35	350	1,5	0,315
U30460 P	25	35	460	2,0	0,535
U30560 P	25	35	560	2,0	0,650
U30660 P	25	35	660	2,0	0,765



(PG / HDG) U Profile

Cable Trays , Cable Ladders , Wiremesh Cable Trays , Trunking Cable Trays

This product is designed for cable tray carrying system. It can be used for different purposes

This product is used by fixing it to the Cable Tray with M8x15 Bolt / Nut.

Ergonomic operation in every assembly area with its suitable design for all cable carrying systems.

www.traycanal.com
export@traycanal.com
+90 534 598 08 65

www.traycanal.com / Support Systems / U Profiles

PRODUCT CODE	HEIGHT	WIDTH	LENGTH	THICKNESS ± %10	WEIGHT(KG/MT)
U5 300 5R P	30	50	3000	1,5	1,085
U5 300 0R P	30	50	3000	2,0	1,396
U5 300 5R H	30	50	3000	1,5	1,176

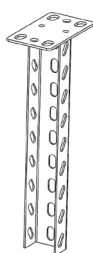

(HDG) U Hanging Support Ceiling (Welded)

Cable Trays , Cable Ladders , Wiremesh Cable Trays , Trunking Cable Trays

This product is designed for cable tray carrying system. It can be used for different purposes

This product is used by fixing it to the Cable Tray with M8x15 Bolt / Nut.

Ergonomic operation in every assembly area with its suitable design for all cable carrying systems.

www.traycanal.com
export@traycanal.com
+90 534 598 08 65

www.traycanal.com / Support Systems / U Hanging Support Ceiling (Welded)

PRODUCT CODE	HEIGHT	WIDTH	LENGTH	THICKNESS ± %10	WEIGHT(KG/PCS)
U5 050 0UC H	30	50	500	2,0	0,935
U5 100 0UC H	30	50	1000	2,0	1,670
U5 300 0UC H	30	50	3000	2,0	4,600

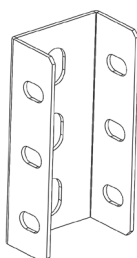

(PG / HDG) U Profile Connector (Vertical)

Cable Trays , Cable Ladders , Wiremesh Cable Trays , Trunking Cable Trays

This product is designed for cable tray carrying system. It can be used for different purposes

This product is used by fixing it to the Cable Tray with M8x15 Bolt / Nut.

Ergonomic operation in every assembly area with its suitable design for all cable carrying systems.

www.traycanal.com
export@traycanal.com
+90 534 598 08 65

www.traycanal.com / Support Systems / U Profile Connectors

PRODUCT CODE	HEIGHT	WIDTH	LENGTH	THICKNESS ± %10	WEIGHT(KG/PCS)
U5 110 20 P	32	51	110	2,0	0,175
U5 110 20 H	32	51	110	2,0	0,184

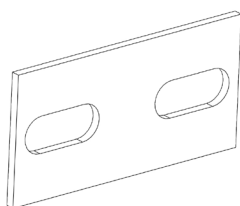

(PG / HDG) Double U Profiles Connector

Cable Trays , Cable Ladders , Wiremesh Cable Trays , Trunking Cable Trays

This product is designed for cable tray carrying system. It can be used for different purposes

This product is used by fixing it to the Cable Tray with M8x15 Bolt / Nut.

Ergonomic operation in every assembly area with its suitable design for all cable carrying systems.

www.traycanal.com
export@traycanal.com
+90 534 598 08 65

www.traycanal.com / Support Systems / U Profiles

PRODUCT CODE	HEIGHT	WIDTH	LENGTH	THICKNESS ± %10	WEIGHT(KG/PCS)
U5 060 20 P	30	60		2,0	0,030
U5 060 20 H	30	60		2,0	0,033

(PG / HDG) U Support Brackets

Cable Trays , Cable Ladders , Wiremesh Cable Trays , Trunking Cable Trays

This product is designed for cable tray carrying system. It can be used for different purposes

This product is used by fixing it to the Cable Tray with M8x15 Bolt / Nut.

Ergonomic operation in every assembly area with its suitable design for all cable carrying systems.

www.traycanal.com
export@traycanal.com
+90 534 598 08 65

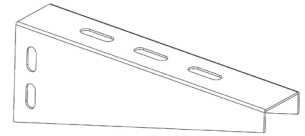

www.traycanal.com / Support Systems / U Support Brackets

PRODUCT CODE	HEIGHT	WIDTH	LENGTH	THICKNESS ± %10	WEIGHT(KG/PCS)
U5 100 US P	80	44	130	1,2	0,109
U5 200 US P	80	44	230	1,2	0,193
U5 300 US P	80	44	330	1,5	0,305
U5 400 US P	80	44	430	1,5	0,434
U5 500 US P	80	44	530	2,0	1,131
U5 600 US P	80	44	630	2,0	1,345
U5 100 US H	80	44	130	1,2	0,120
U5 200 US H	80	44	230	1,2	0,213
U5 300 US H	80	44	330	1,5	0,337
U5 400 US H	80	44	430	1,5	0,479
U5 500 US H	80	44	530	2,0	1,250
U5 600 US H	80	44	630	2,0	1,486

(PG / HDG) U Hanging Support (Adjustable)

Cable Trays , Cable Ladders , Wiremesh Cable Trays , Trunking Cable Trays

This product is designed for cable tray carrying system. It can be used for different purposes

This product is used by fixing it to the Cable Tray with M8x15 Bolt / Nut.

Ergonomic operation in every assembly area with its suitable design for all cable carrying systems.

www.traycanal.com
export@traycanal.com
+90 534 598 08 65

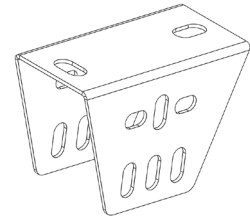

www.traycanal.com / Support Systems / U Hanging Support (Adjustable)

PRODUCT CODE	HEIGHT	WIDTH	LENGTH	THICKNESS ± %10	WEIGHT(KG/PCS)
U5 UH P	77	115	100	2,0	0,342
U5 UH H	77	115	100	2,0	0,378

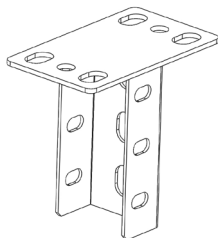

(PG / HDG) U Hanging Support (Welded)

Easy Connector / No Cover Clamp / No Connection Coupler

This product is designed for cable tray carrying system. It can be used for different purposes

This product is used by fixing it to the Cable Tray with M8x15 Bolt / Nut.

Ergonomic operation in every assembly area with its suitable design for all cable carrying systems.

www.traycanal.com
export@traycanal.com
+90 534 598 08 65

www.traycanal.com / Support Systems / U Hanging Support (Welded)

PRODUCT CODE	HEIGHT	WIDTH	LENGTH	THICKNESS ± %10	WEIGHT(KG/PCS)
U5 UHW H	32	51	110	2,0	0,357



(PG / HDG) Grounding Strap

Cable Trays , Cable Ladders , Wiremesh Cable Trays , Trunking Cable Trays

www.traycanal.com
export@traycanal.com
+90 534 598 08 65

www.traycanal.com / PG Grounding Strap

PRODUCT CODE	CONDUCTOR (MM)	LENGHT(MT)	WEIGHT(KG/MT)
TGS-303 P	30x3	50	0,730
TGS-335 P	30x3,5	50	0,850
TGS-304 P	30x4	50	0,960
TGS-305 P	30x5	10	1,200
TGS-353 P	35x3	50	0,850
TGS-254 P	25x4	50	0,800
TGS-403 P	40x3	50	0,960
TGS-404 P	40x4	40	1,300
TGS-405 P	40x5	40	1,600
TGS-504 P	50x4	40	1,600
TGS-505 P	50x5	40	2,000



(PG / HDG) Grounding Strap

Cable Trays , Cable Ladders , Wiremesh Cable Trays , Trunking Cable Trays

www.traycanal.com
export@traycanal.com
+90 534 598 08 65

www.traycanal.com / PG Grounding Strap

PRODUCT CODE	CONDUCTOR (MM)	LENGHT(MT)	WEIGHT(KG/MT)
TGS-303 H	30x3	6	0,730
TGS-335 H	30x3,5	6	0,850
TGS-304 H	30x4	6	0,960
TGS-305 H	30x5	6	1,200
TGS-353 H	35x3	6	0,850
TGS-254 H	25x4	6	0,800
TGS-403 H	40x3	6	0,960
TGS-404 H	40x4	6	1,300
TGS-405 H	40x5	6	1,600
TGS-504 H	50x4	6	1,600
TGS-505 H	50x5	6	2,000
TGS-506 H	50X6	6	2,400
TGS-605 H	60X5	6	2,400



Earthing Connector-Cu

Cable Trays , Cable Ladders , Wiremesh Cable Trays , Trunking Cable Trays

It is a connection part for C Profiles. It is for the use of the assembly of Cable Trays in different functions.

This product is a cable tray carrier system accessory. It can be used for different purposes.

Ergonomic operation in every assembly area with its suitable design for all cable carrying systems.

www.traycanal.com
export@traycanal.com
+90 534 598 08 65

www.traycanal.com / Hardwares / Earthing Connector-Cu

PRODUCT CODE	LENGTH	THICKNESS	WEIGHT(KG/PCS)
EC70CU	70	0,8	0,050



Earthing Connector-Tin

Cable Trays , Cable Ladders , Wiremesh Cable Trays , Trunking Cable Trays

It is a connection part for C Profiles. It is for the use of the assembly of Cable Trays in different functions.

This product is a cable tray carrier system accessory. It can be used for different purposes.

Ergonomic operation in every assembly area with its suitable design for all cable carrying systems.

www.traycanal.com
export@traycanal.com
+90 534 598 08 65

www.traycanal.com / Hardwares / Earthing Connector-Tin

PRODUCT CODE	LENGTH	THICKNESS	WEIGHT(KG/PCS)
EC70TN	70	0,8	0,050



Bonding Jumper-1 Cu & Tin

Cable Trays , Cable Ladders , Wiremesh Cable Trays , Trunking Cable Trays

It is a connection part for C Profiles. It is for the use of the assembly of Cable Trays in different functions.

This product is a cable tray carrier system accessory. It can be used for different purposes.

Ergonomic operation in every assembly area with its suitable design for all cable carrying systems.

www.traycanal.com
export@traycanal.com
+90 534 598 08 65

www.traycanal.com / Hardwares / Bonding Jumper-1 Cu & Tin

PRODUCT CODE	LENGTH	METRIC	SECTION
BJ1100CU	100	M6	10
BJ1210CU	210	M6	10
BJ1100TN	100	M6	10
BJ1100TN	210	M6	10



Bonding Jumper-2 Cu & Tin

Cable Trays , Cable Ladders , Wiremesh Cable Trays , Trunking Cable Trays

It is a connection part for C Profiles. It is for the use of the assembly of Cable Trays in different functions.

This product is a cable tray carrier system accessory. It can be used for different purposes.

Ergonomic operation in every assembly area with its suitable design for all cable carrying systems.

www.traycanal.com
export@traycanal.com
+90 534 598 08 65

www.traycanal.com / Hardwares / Bonding Jumper-1 Cu & Tin

PRODUCT CODE	LENGTH	METRIC	SECTION
BJ2100CU	100	M8	10
BJ2210CU	210	M8	10
BJ2280CU	280	M8	10
BJ2100TN	100	M8	10
BJ2210TN	210	M8	10
BJ2280TN	280	M8	10



(HDG) EARTHING ELECTRODE

Cable Trays , Cable Ladders , Wiremesh Cable Trays , Trunking Cable Trays

www.traycanal.com
export@traycanal.com
+90 534 598 08 65

www.traycanal.com / PG Earthing Electrode

PRODUCT CODE	THICKNESS (MM)	SIZE	LENGTH (MM)	WEIGHT(KG/PCS)
TEE 40X40X4-10	4,0	40X40	1000	2,515
TEE 40X40X4-15	4,0	40X40	1500	3,770
TTE 50x50x4 -10	4,0	50X50	1000	3,140
TEE 50X50X4-15	4,0	50X50	1500	4,710
TEE 60X60X4-10	4,0	60X60	1000	3,770
TEE 60X60X4-15	4,0	60X60	1500	5,655
TEE 40X40X5-10	5,0	40X40	1000	3,140
TEE 40X40X5-15	5,0	40X40	1500	4,710

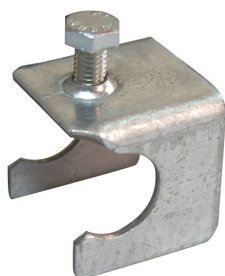

(HDG) Jointing Clamp

Cable Trays , Cable Ladders , Wiremesh Cable Trays , Trunking Cable Trays

www.traycanal.com
export@traycanal.com
+90 534 598 08 65

www.traycanal.com / Jointing Clamp

PRODUCT CODE	CONTUCTOR	SECTION	WEIGHT(KG/pcs)
TKJC-1	16-20	30x3	0,080
TKJC-2	22-26	30x3	0,080
TKJC-3	28-32	30x3	0,090
TKJC-4	16-20	30x3	0,120
TKJC-5	26-32	30x3	0,400

(PG) ACTIVE LIGHTNING ARRESTER

Cable Trays , Cable Ladders , Wiremesh Cable Trays , Trunking Cable Trays

www.traycanal.com
export@traycanal.com
+90 534 598 08 65



www.traycanal.com / Active Lightning Arrester

PRODUCT CODE	SIZE	LENGHTS	WEIGHT(KG/PCS)
TACL-1	0,85 M	60	9,360
TACL-2	75X37X111		0,130
TACL-3		5	0,300
TACL-4		10	0,600